

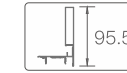

S50AL

梦幻抽 (低抽) DREAM BOX (LOW DRAWER)



载重: 35公斤
长度: 250-600mm
抽帮高度: 95.5mm
面板左右调节: ± 1.2
面板上下调节: ± 2
面板倾斜调节: $-1.5, +4$
抽屉前后调节: 0-5

Load capacity: 35Kg
Length: 250-600mm
Height of drawer sides: 95.5mm
Front Panel width adjustment: ± 1.2
Front Panel height adjustment: ± 2
Front Panel tilt adjustment: $-1.5, +4$
Drawer depth adjustment: 0-5



滑轨安装尺寸 Installation dimensions

LW=柜内净宽 Internal cabinet width
KB=柜体宽度 Cabinet width
NL=滑轨标寸长度 Slide length
LT=柜内深度 Internal cabinet depth

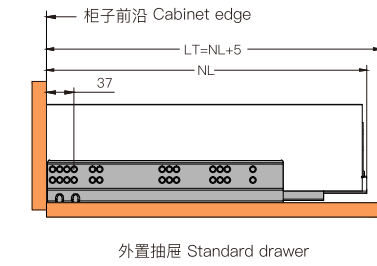
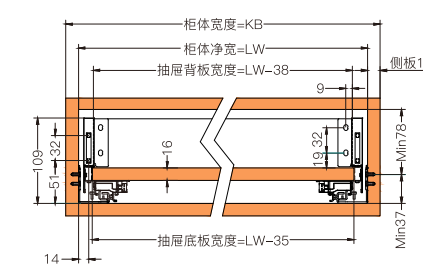

外置抽屉 Standard drawer

滑轨安装孔位 Hole position

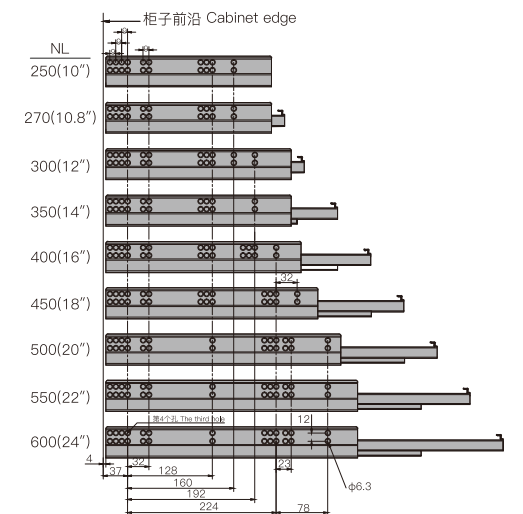

产品配件 Accessories

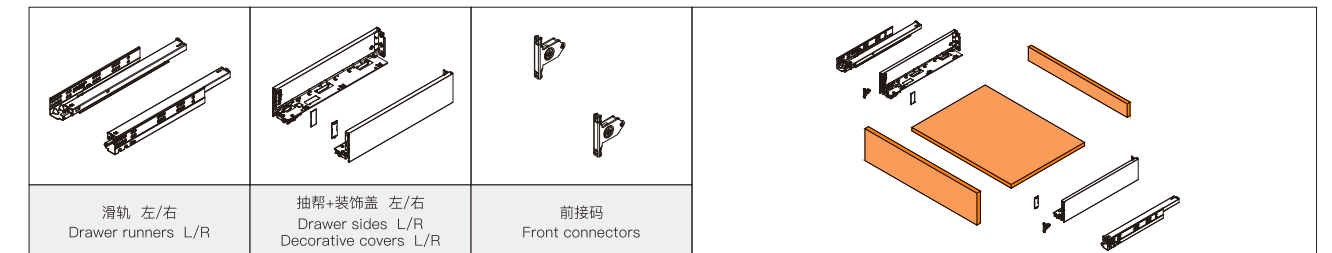

抽屉前面板、后背板、底板尺寸和钻孔(mm) Front panel, Rear panel, Base panel and drilling

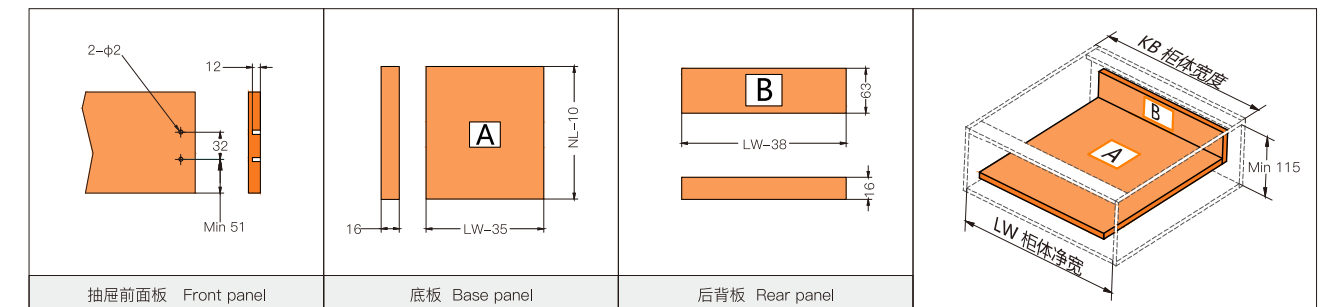

DREAM BOX
S50梦幻抽

S50AM

梦幻抽 (中抽) DREAM BOX (MEDIUM DRAWER)

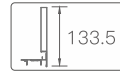

载重: 35公斤
长度: 250-600mm
抽帮高度: 133.5mm
面板左右调节: ± 1.2
面板上下调节: ± 2
面板倾斜调节: $-1.5, +4$
抽屉前后调节: 0-5

Load capacity: 35Kg
Length: 250-600mm
Height of drawer sides: 133.5mm
Front Panel width adjustment: ± 1.2
Front Panel height adjustment: ± 2
Front Panel tilt adjustment: $-1.5, +4$
Drawer depth adjustment: 0-5



滑轨安装尺寸 Installation dimensions

LW=柜内净宽 Internal cabinet width
KB=柜体宽度 Cabinet width
NL=滑轨标称长度 Slide length
LT=柜内深度 Internal cabinet depth

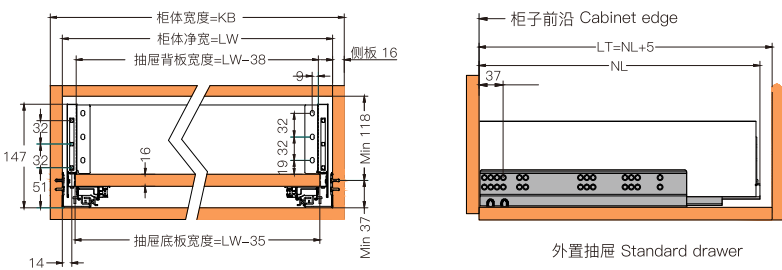

滑轨安装孔位 Hole position

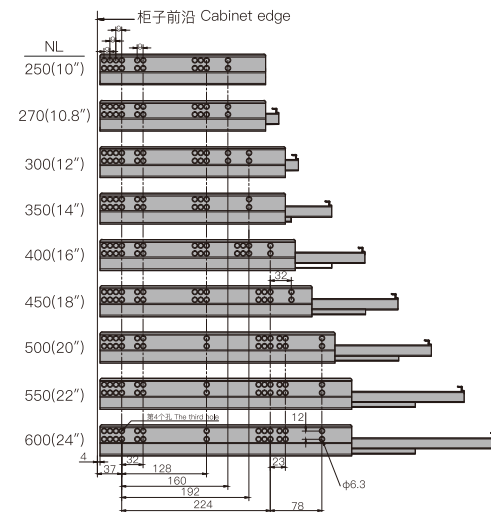

产品配件 Accessories

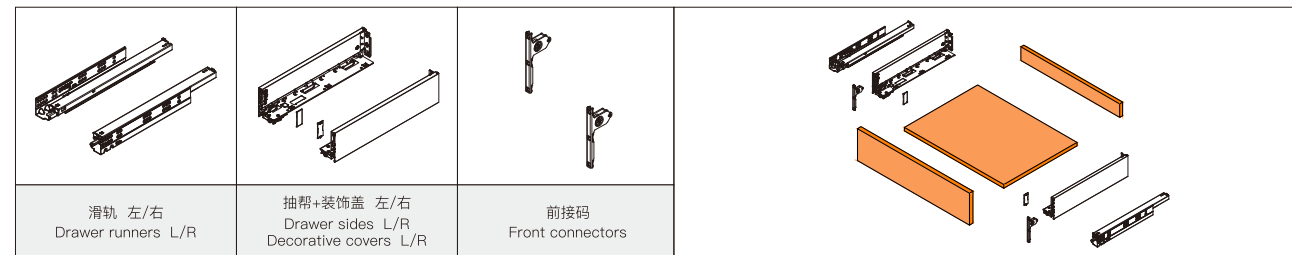

抽屉前面板、后背板、底板尺寸和钻孔(mm) Front panel, Rear panel, Base panel and drilling

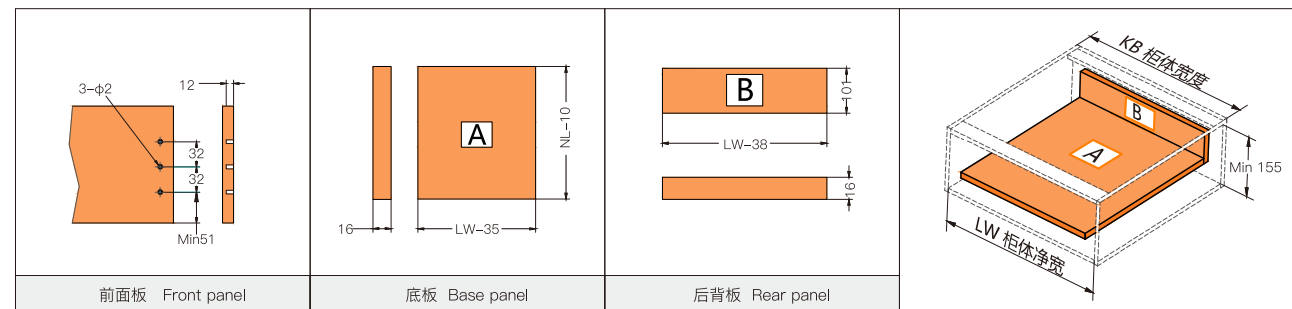

S50AH

梦幻抽 (高抽) DREAM BOX (HIGH DRAWER)

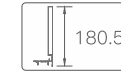

载重: 35公斤
长度: 250-600mm
抽帮高度: 180.5mm
面板左右调节: ± 1.2
面板上下调节: ± 2
面板倾斜调节: $-1.5, +4$
抽屉前后调节: 0-5

Load capacity: 35Kg
Length: 250-600mm
Height of drawer sides: 180.5mm
Front Panel width adjustment: ± 1.2
Front Panel height adjustment: ± 2
Front Panel tilt adjustment: $-1.5, +4$
Drawer depth adjustment: 0-5

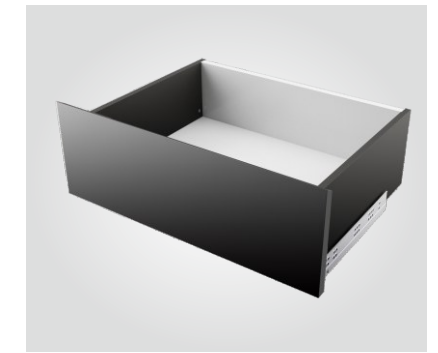

滑轨安装尺寸 Installation dimensions

LW=柜内净宽 Internal cabinet width
KB=柜体宽度 Cabinet width
NL=滑轨标称长度 Slide length
LT=柜内深度 Internal cabinet depth

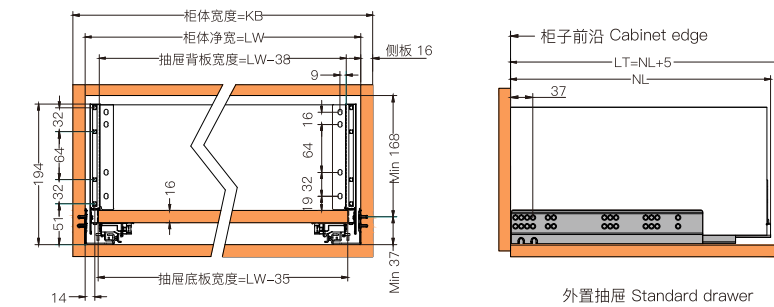

滑轨安装孔位 Hole position

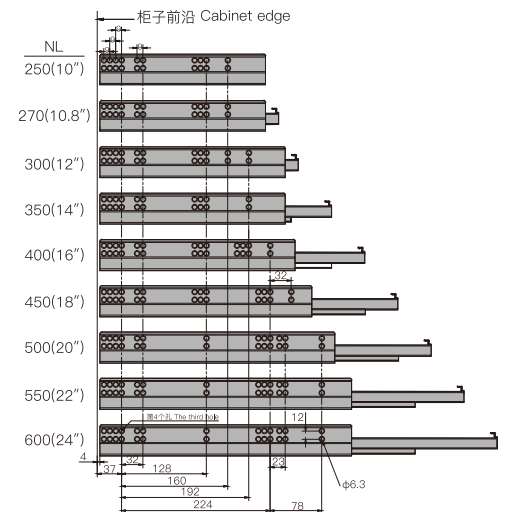

产品配件 Accessories

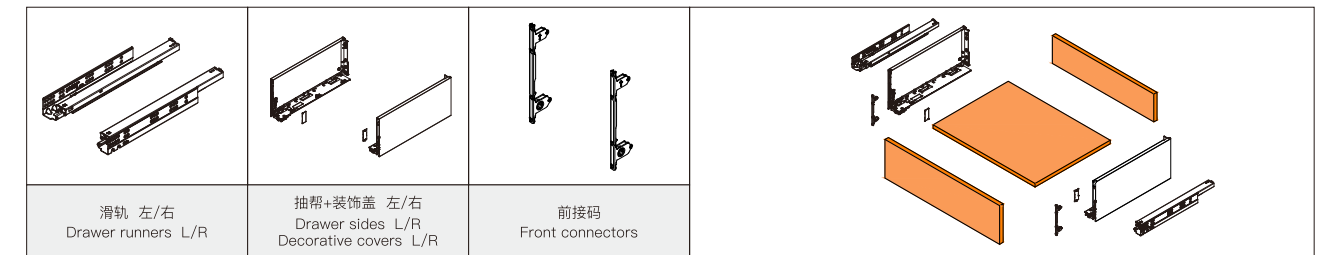

抽屉前面板、后背板、底板尺寸和钻孔(mm) Front panel, Rear panel, Base panel and drilling

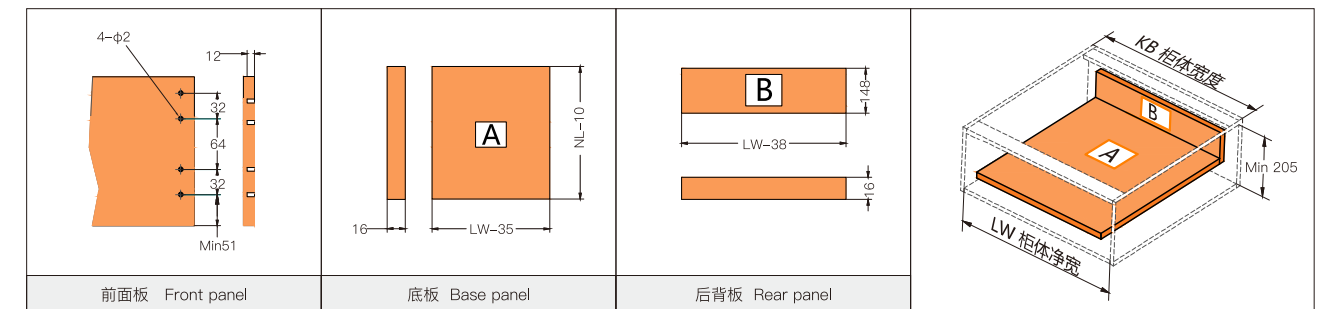

S50AL内抽

梦幻抽内抽 (低抽) DREAM BOX (LOW INNER DRAWER)

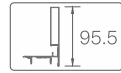

载重: 35公斤
长度: 250-600mm
抽帮高度: 95.5mm
面板倾斜调节: -1.5,+4
抽屉前后调节: 0-5

Load capacity: 35Kg
Length: 250-600mm
Height of drawer sides: 95.5mm
Front Panel tilt adjustment: -1.5,+4
Drawer depth adjustment: 0-5

滑轨安装尺寸 Installation dimensions

LW=柜内净宽 Internal cabinet width
KB=柜体宽度 Cabinet width
NL=滑轨标寸长度 Slide length
LT=柜内深度 Internal cabinet depth

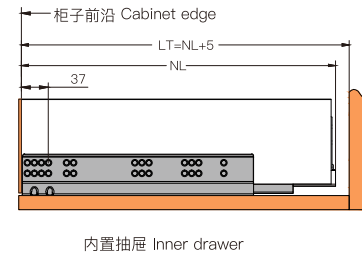
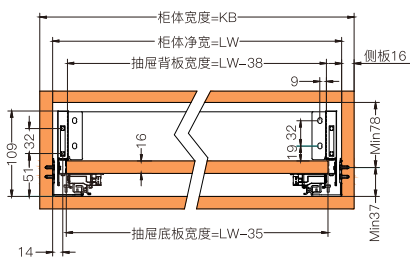

滑轨安装孔位 Hole position

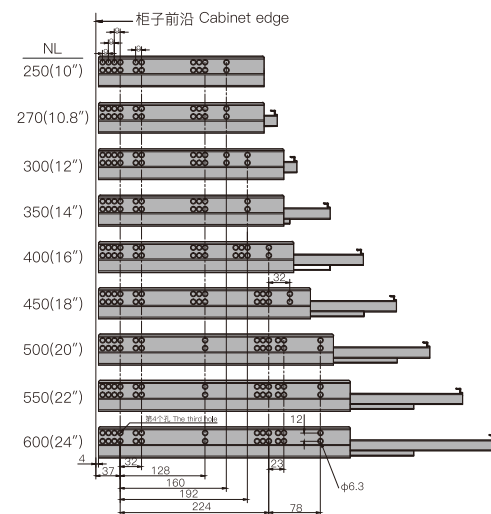

产品配件 Accessories

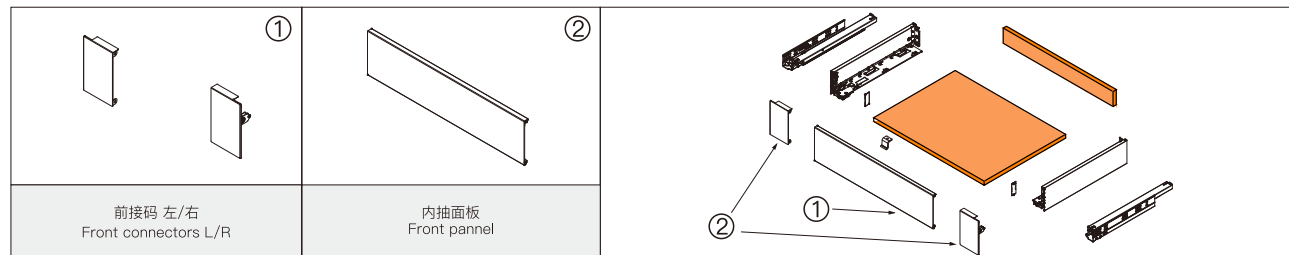

内抽面板、后背板、底板尺寸(mm) Front panel, Rear panel, Base panel size

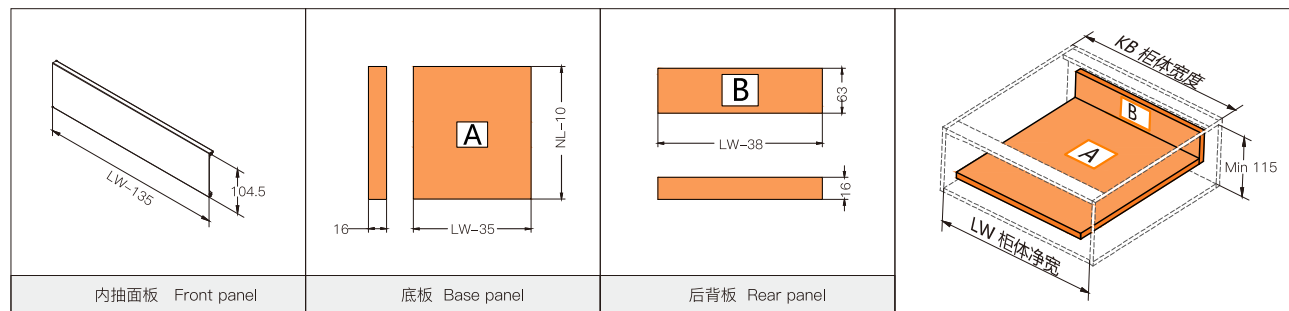

S50AL内抽 (玻璃)

梦幻抽内抽 (低抽) 适配玻璃低抽面板 DREAM BOX (LOW INNER DRAWER WITH GLASS FRONT PANEL)

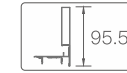

载重: 35公斤
长度: 250-600mm
抽帮高度: 95.5mm
面板倾斜调节: -1.5,+4
抽屉前后调节: 0-5

Load capacity: 35Kg
Length: 250-600mm
Height of drawer sides: 95.5mm
Front Panel tilt adjustment: -1.5,+4
Drawer depth adjustment: 0-5

滑轨安装尺寸 Installation dimensions

LW=柜内净宽 Internal cabinet width
KB=柜体宽度 Cabinet width
NL=滑轨标寸长度 Slide length
LT=柜内深度 Internal cabinet depth

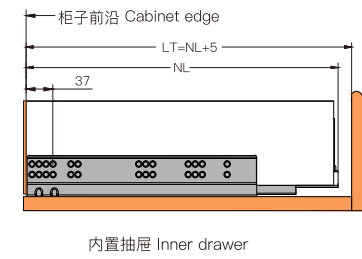
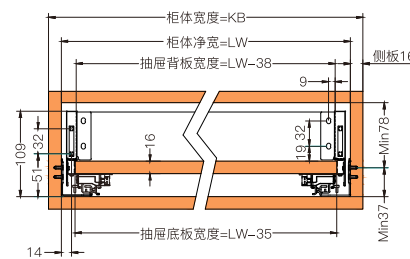

滑轨安装孔位 Hole position

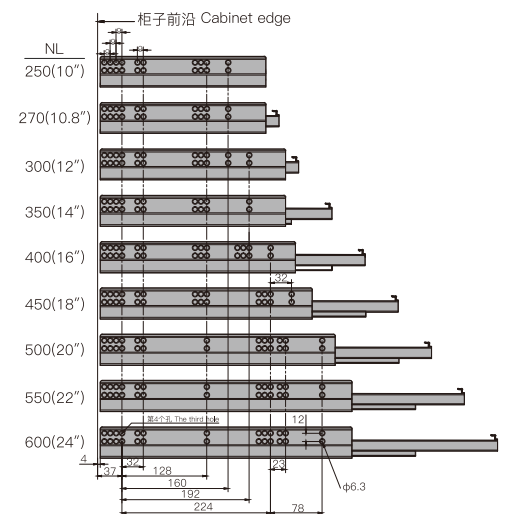

产品配件 Accessories

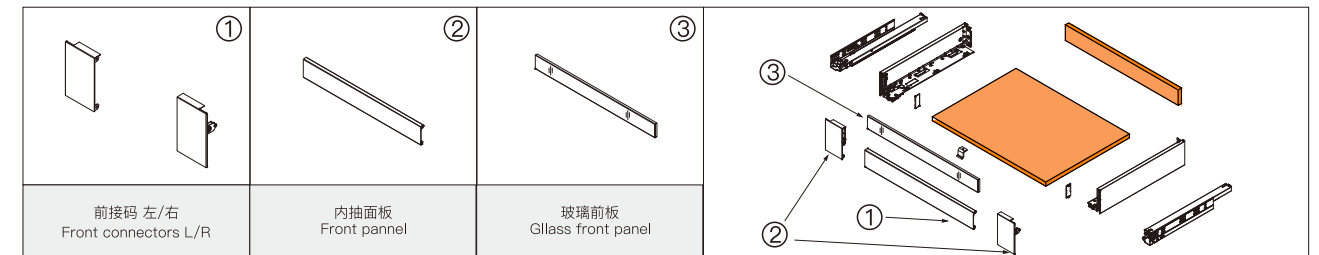

内抽面板、玻璃前板、后背板、底板尺寸(mm) Front panel, Glass, Rear panel, Base panel size

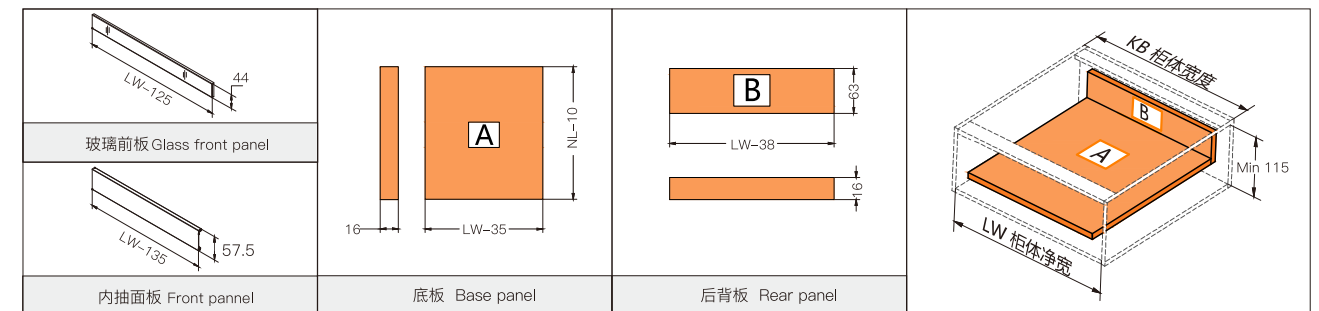

S50AH内抽 (方杆)

梦幻抽内抽 (高抽)
适配方杆高抽面板

DREAM BOX (HIGH INNER DRAWER WITH SQUARE RAIL)

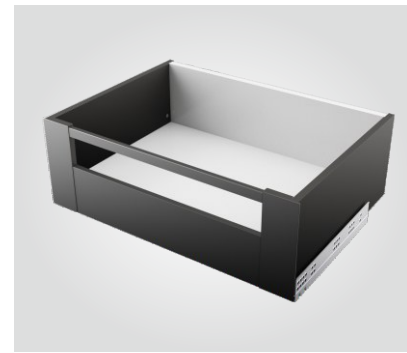

载重: 35公斤
长度: 250-600mm
抽帮高度: 180.5mm
面板倾斜调节: -1.5,+4
抽屉前后调节: 0-5

Load capacity: 35Kg
Length: 250-600mm
Height of drawer sides: 180.5mm
Front Panel tilt adjustment: -1.5,+4
Drawer depth adjustment: 0-5

滑轨安装尺寸 Installation dimensions

LW=柜内宽度 Internal cabinet width
KB=柜体宽度 Cabinet width
NL=滑轨标称长度 Slide length
LT=柜内深度 Internal cabinet depth

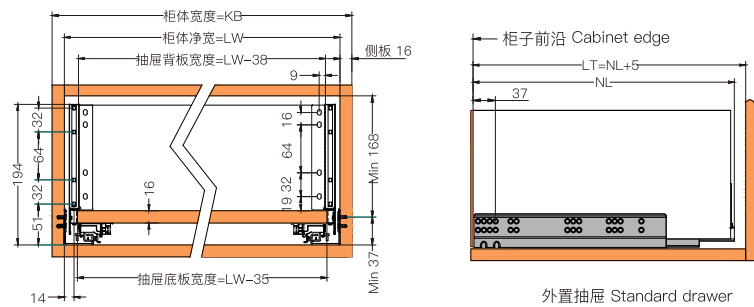

滑轨安装孔位 Hole position

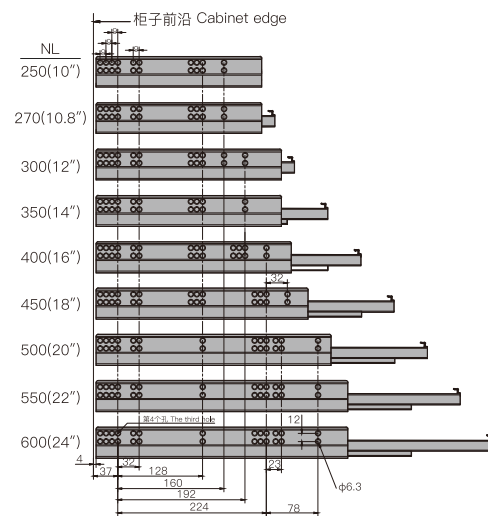

产品配件 Accessories

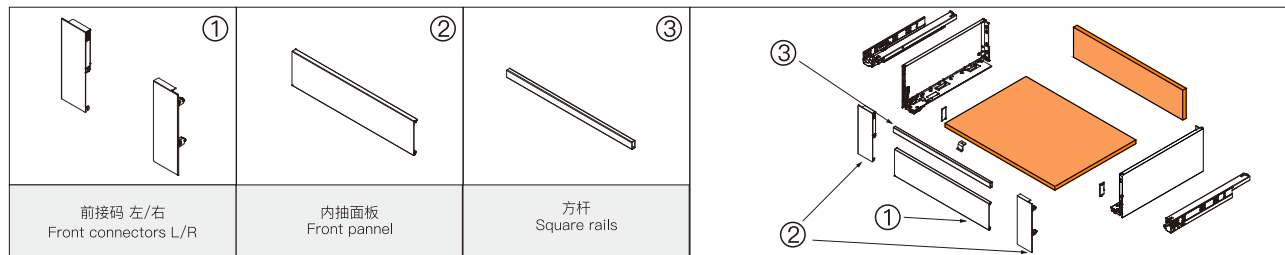

内抽面板、方杆、后背板、底板尺寸(mm) Front panel, Square rails, Rear panel, Base panel size

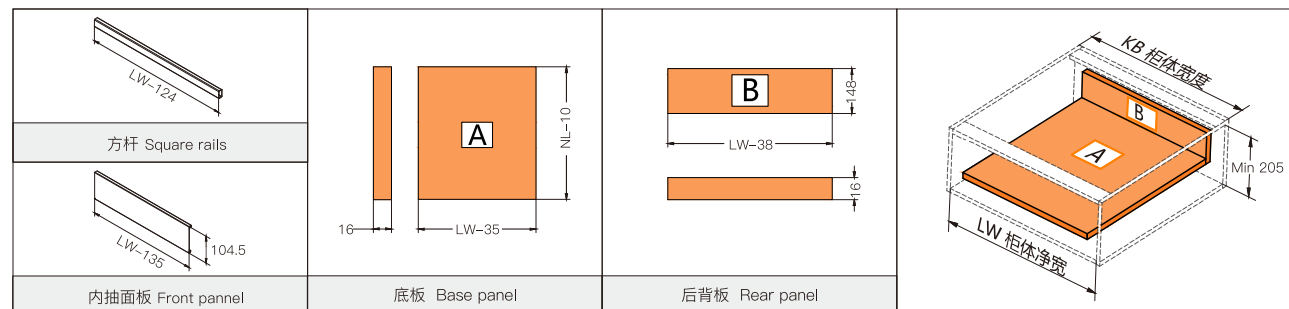

S50AH内抽 (玻璃)

梦幻抽内抽 (高抽)
适配玻璃高抽面板

DREAM BOX (HIGH INNER DRAWER WITH GLASS FRONT PANEL)

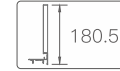

载重: 35公斤
长度: 250-600mm
抽帮高度: 180.5mm
面板倾斜调节: -1.5,+4
抽屉前后调节: 0-5

Load capacity: 35Kg
Length: 250-600mm
Height of drawer sides: 179mm
Front Panel tilt adjustment: -1.5,+4
Drawer depth adjustment: 0-5

滑轨安装尺寸 Installation dimensions

LW=柜内宽度 Internal cabinet width
KB=柜体宽度 Cabinet width
NL=滑轨标称长度 Slide length
LT=柜内深度 Internal cabinet depth

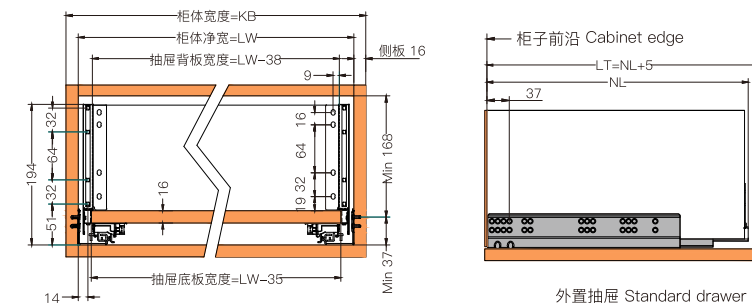

滑轨安装孔位 Hole position

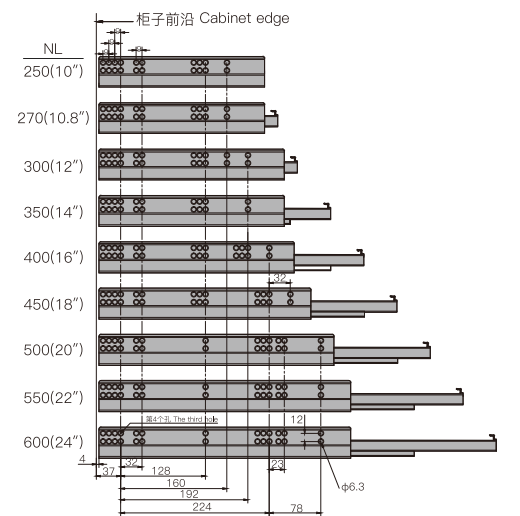

产品配件 Accessories

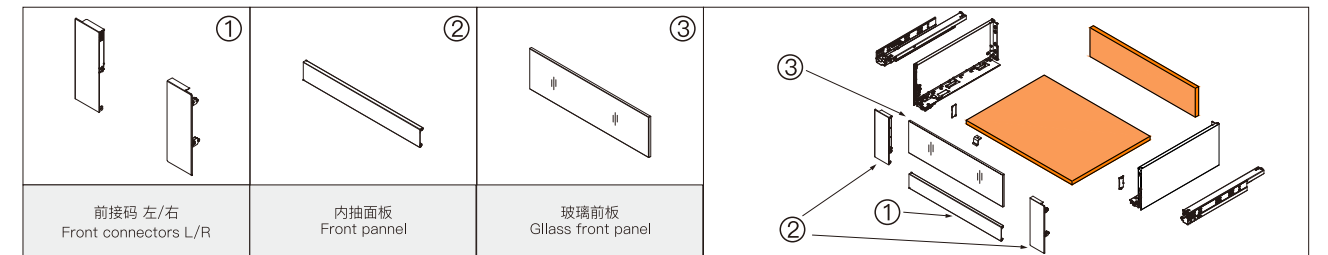

内抽面板、玻璃前板、后背板、底板尺寸(mm) Front panel, Glass, Rear panel, Base panel size

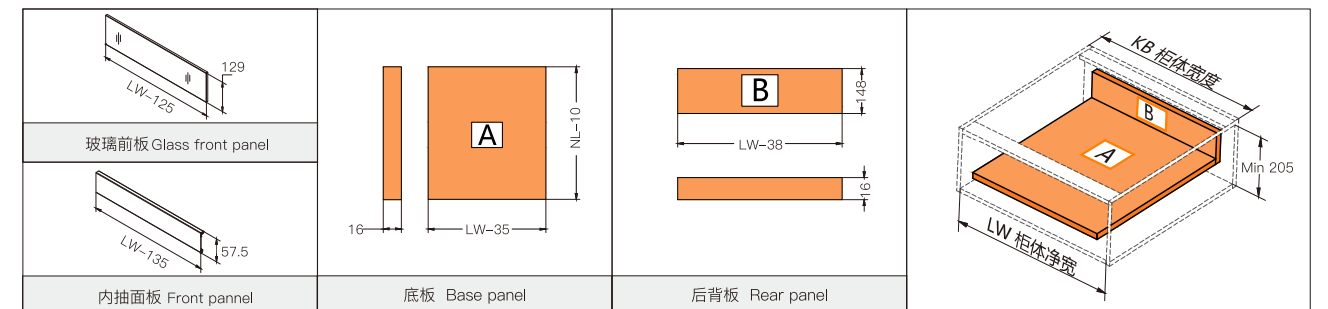



S50BL

梦幻玻璃抽 (低抽)

DREAM BOX (LOW DRAWER WITH GLASS-BOXSIDE)

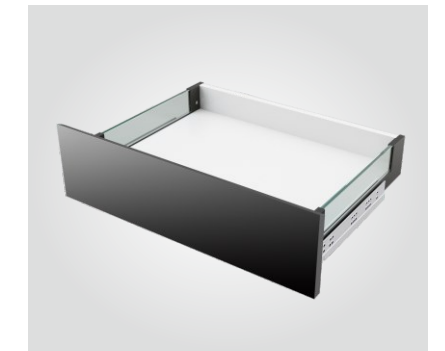

载重: 35公斤
 长度: 250-600mm
 抽帮高度: 94mm
 面板左右调节: ± 1.2
 面板上下调节: ± 2
 面板倾斜调节: $-1.5, +4$
 抽屉前后调节: 0-5

Load capacity: 35Kg
 Length: 250-600mm
 Height of drawer sides: 94mm
 Front Panel width adjustment: ± 1.2
 Front Panel height adjustment: ± 2
 Front Panel tilt adjustment: $-1.5, +4$
 Drawer depth adjustment: 0-5

滑轨安装尺寸 Installation dimensions

LW=柜内净宽 Internal cabinet width
 KB=柜体宽度 Cabinet width
 NL=滑轨标称长度 Slide length
 LT=柜内深度 Internal cabinet depth

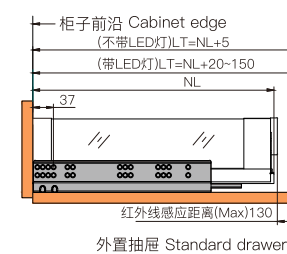
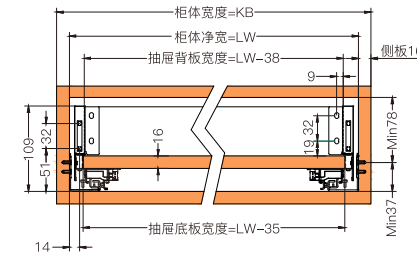

滑轨安装孔位 Hole position

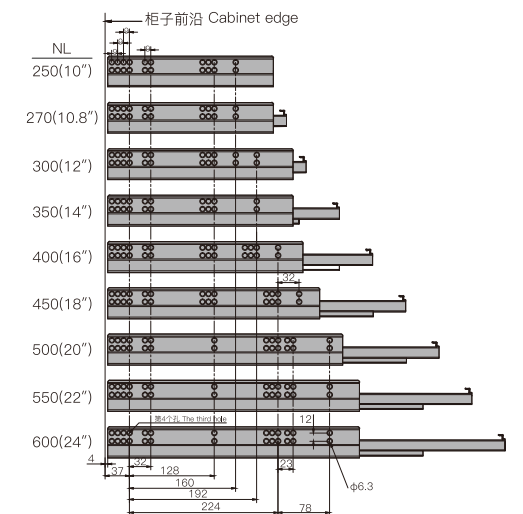

产品配件 Accessories

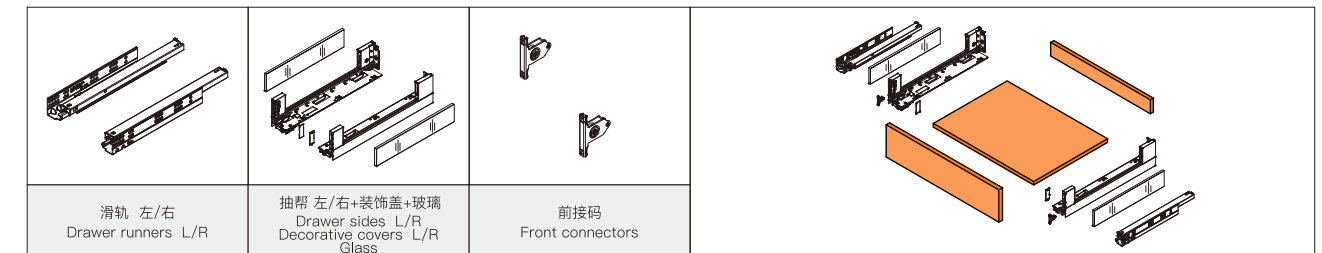

抽屉前面板、后背板、底板尺寸和钻孔(mm) Front panel, Rear panel, Base panel and drilling

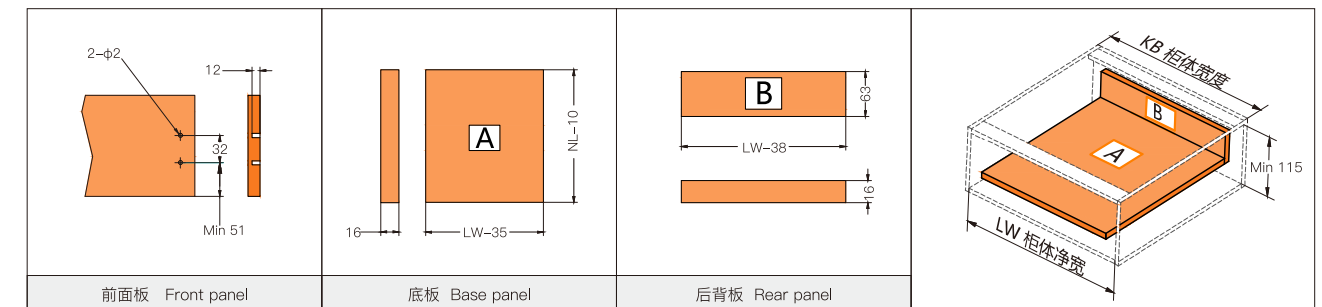

DREAM BOX (GLASS-BOXSIDE)
 S50 梦幻玻璃抽

S50BM

梦幻玻璃抽 (中抽)

DREAM BOX (MEDIUM DRAWER WITH GLASS-BOXSIDE)



载重: 35公斤
 长度: 250-600mm
 抽帮高度: 132mm
 面板左右调节: ± 1.2
 面板上下调节: ± 2
 面板倾斜调节: $-1.5, +4$
 抽屉前后调节: 0-5

Load capacity: 35Kg
 Length: 250-600mm
 Height of drawer sides: 132mm
 Front Panel width adjustment: ± 1.2
 Front Panel height adjustment: ± 2
 Front Panel tilt adjustment: $-1.5, +4$
 Drawer depth adjustment: 0-5



滑轨安装尺寸 Installation dimensions

LW=柜内净宽 Internal cabinet width
 KB=柜体宽度 Cabinet width
 NL=滑轨标寸长度 Slide length
 LT=柜内深度 Internal cabinet depth

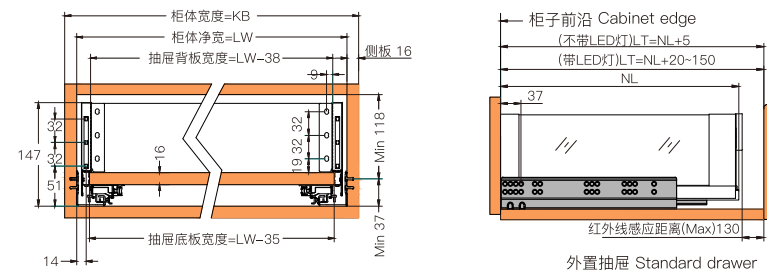

滑轨安装孔位 Hole position

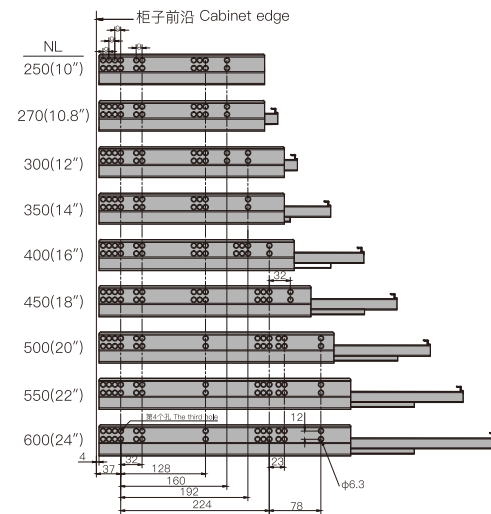

产品配件 Accessories

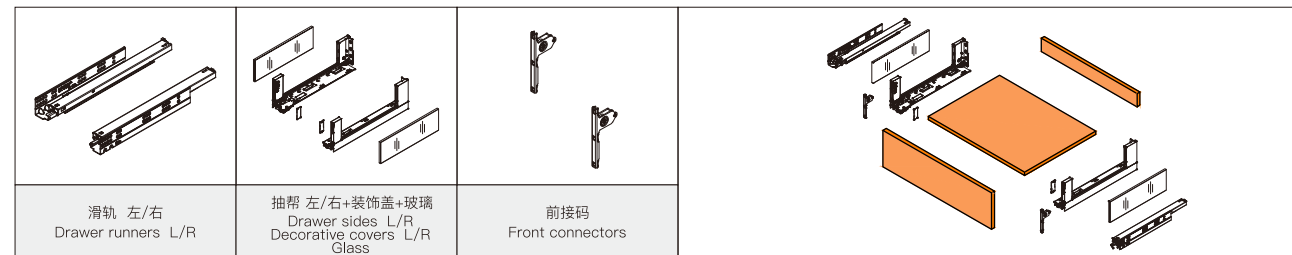

抽屉前面板、后背板、底板尺寸和钻孔(mm) Front panel, Rear panel, Base panel and drilling

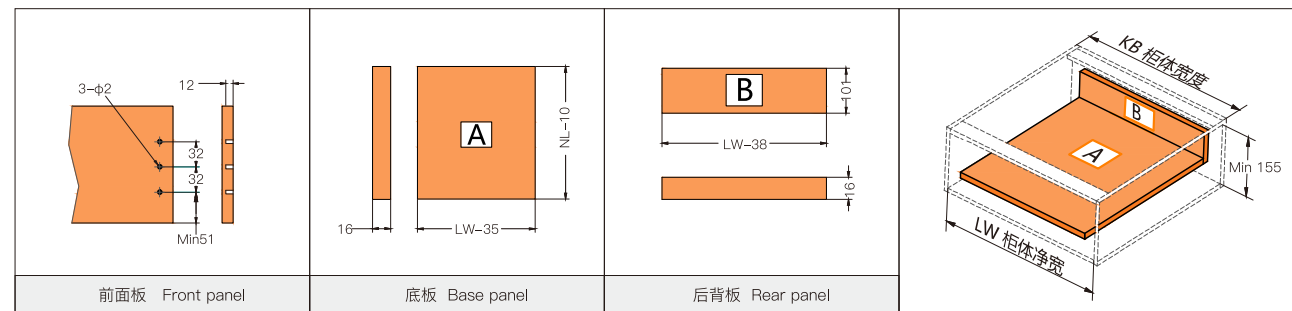

S50BH

梦幻玻璃抽 (高抽)

DREAM BOX (HIGH DRAWER WITH GLASS-BOXSIDE)

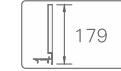

载重: 35公斤
 长度: 250-600mm
 抽帮高度: 179mm
 面板左右调节: ± 1.2
 面板上下调节: ± 2
 面板倾斜调节: $-1.5, +4$
 抽屉前后调节: 0-5

Load capacity: 35Kg
 Length: 250-600mm
 Height of drawer sides: 179mm
 Front Panel width adjustment: ± 1.2
 Front Panel height adjustment: ± 2
 Front Panel tilt adjustment: $-1.5, +4$
 Drawer depth adjustment: 0-5

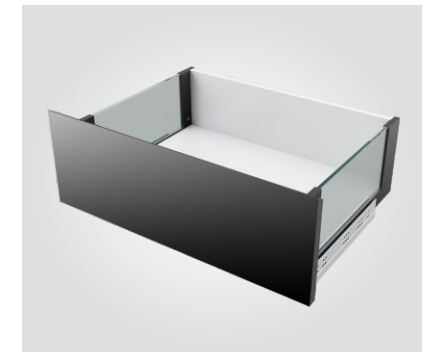

滑轨安装尺寸 Installation dimensions

LW=柜内净宽 Internal cabinet width
 KB=柜体宽度 Cabinet width
 NL=滑轨标寸长度 Slide length
 LT=柜内深度 Internal cabinet depth

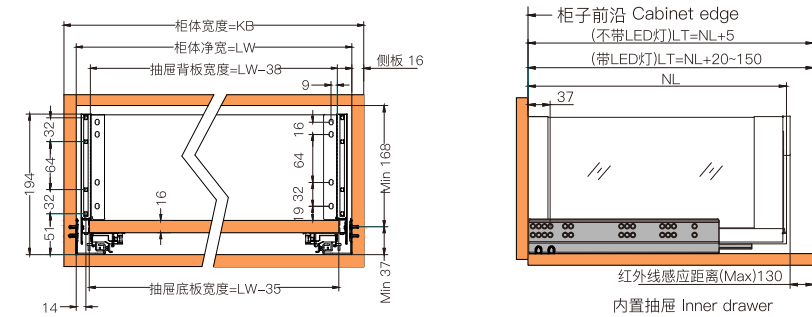

滑轨安装孔位 Hole position

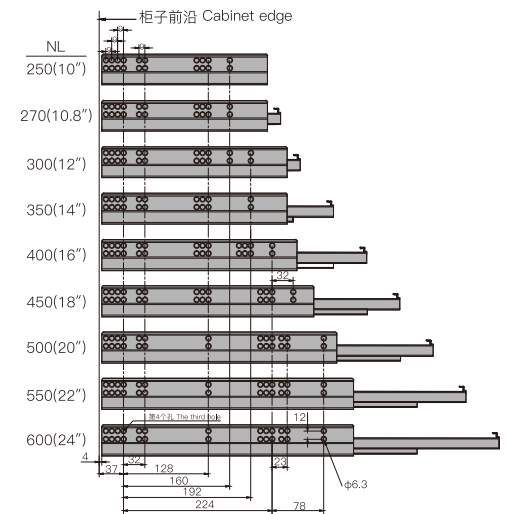

产品配件 Accessories

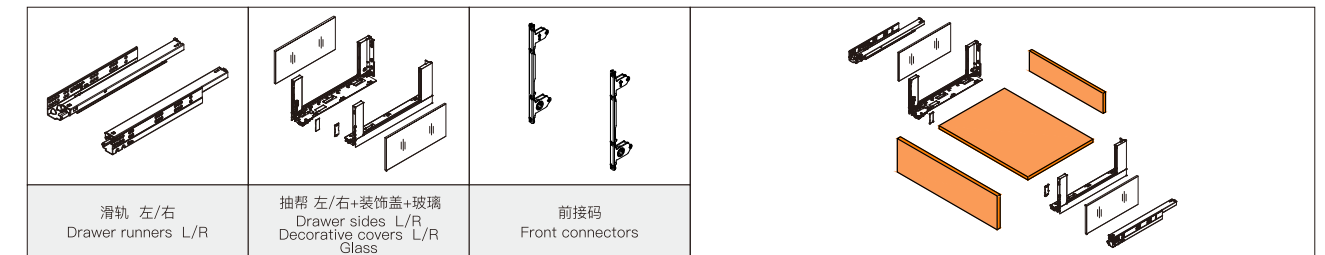

抽屉前面板、后背板、底板尺寸和钻孔(mm) Front panel, Rear panel, Base panel and drilling

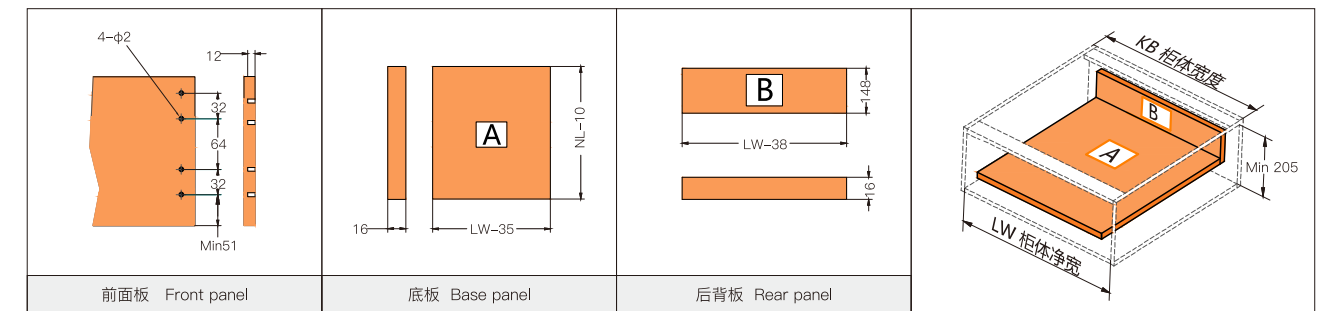

S50BL内抽

梦幻玻璃抽内抽 (低抽)

DREAM BOX (LOW INNER DRAWER WITH GLASS-BOXSIDE)

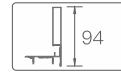

载重: 35公斤
长度: 250-600mm
抽帮高度: 94mm
面板倾斜调节: -1.5,+4
抽屉前后调节: 0-5

Load capacity: 35Kg
Length: 250-600mm
Height of drawer sides: 94mm
Front Panel tilt adjustment: -1.5,+4
Drawer depth adjustment: 0-5

滑轨安装尺寸 Installation dimensions

LW=柜内净宽 Internal cabinet width
KB=柜体宽度 Cabinet width
NL=滑轨标寸长度 Slide length
LT=柜内深度 Internal cabinet depth

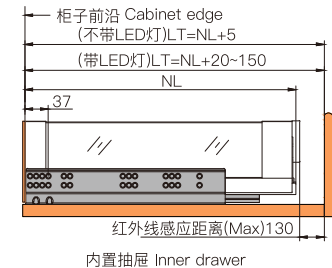
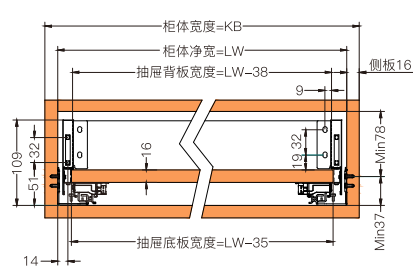

滑轨安装孔位 Hole position

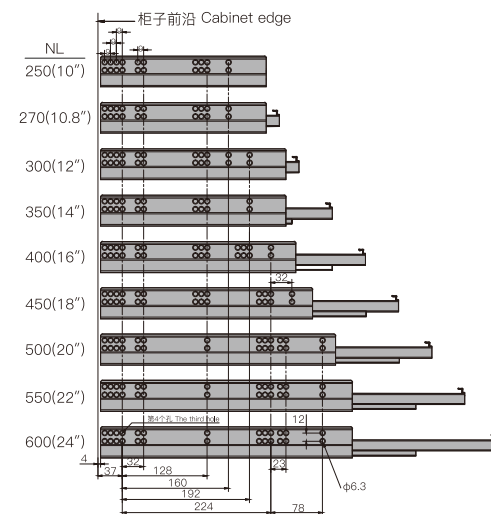

产品配件 Accessories

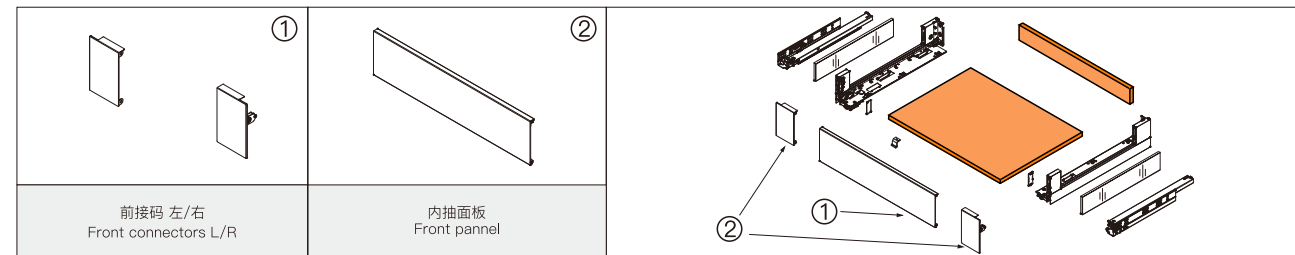

内抽面板、后背板、底板尺寸(mm) Front panel, Rear panel, Base panel size

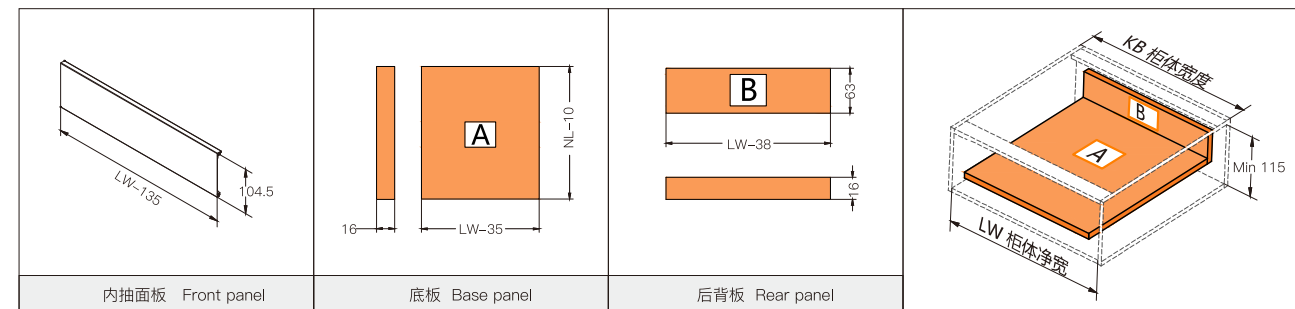

S50BL内抽 (玻璃)

梦幻玻璃抽内抽 (低抽)

适配玻璃低抽面板

DREAM BOX (LOW INNER DRAWER WITH GLASS-BOXSIDE AND GLASS FRONT PANEL)



载重: 35公斤
长度: 250-600mm
抽帮高度: 94mm
面板倾斜调节: -1.5,+4
抽屉前后调节: 0-5

Load capacity: 35Kg
Length: 250-600mm
Height of drawer sides: 94mm
Front Panel tilt adjustment: -1.5,+4
Drawer depth adjustment: 0-5

滑轨安装尺寸 Installation dimensions

LW=柜内净宽 Internal cabinet width
KB=柜体宽度 Cabinet width
NL=滑轨标寸长度 Slide length
LT=柜内深度 Internal cabinet depth

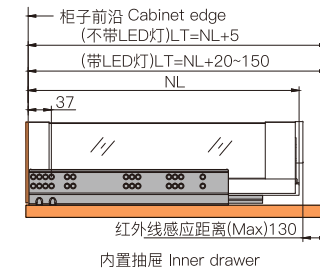
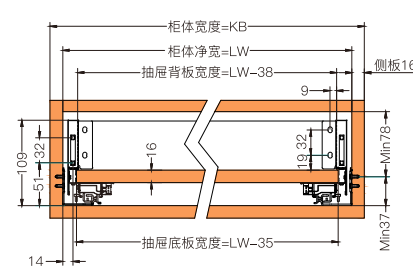

滑轨安装孔位 Hole position

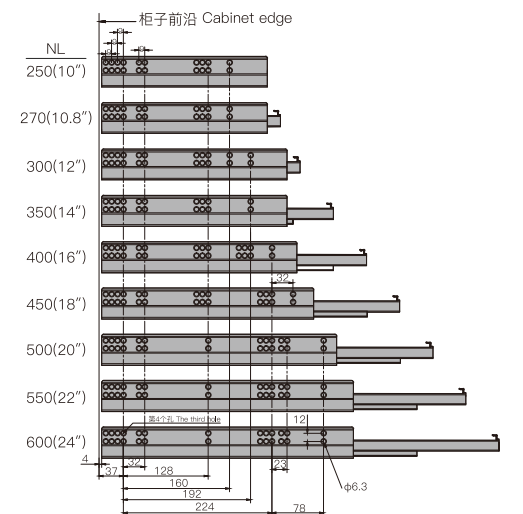

产品配件 Accessories

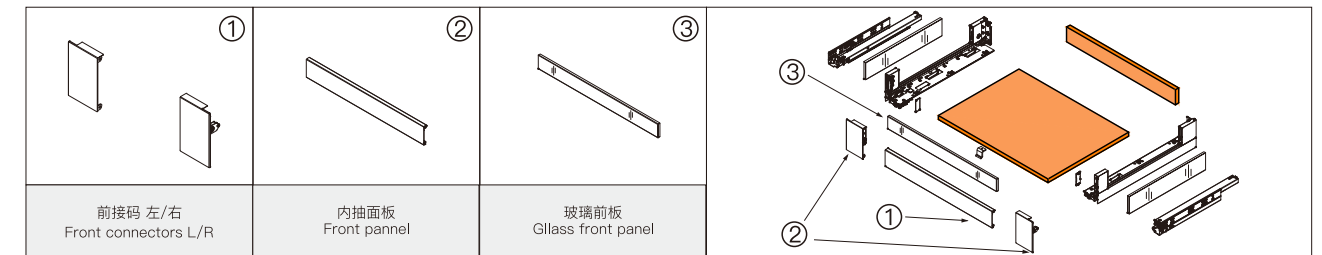

内抽面板、玻璃前板、后背板、底板尺寸(mm) Front panel, Glass, Rear panel, Base panel size

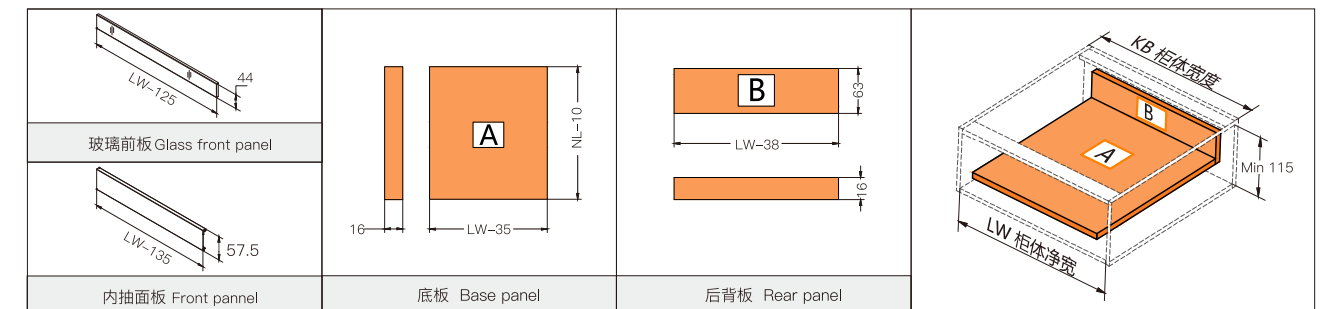

S50BM内抽 (方杆)

梦幻玻璃抽内抽 (中抽) 适配方杆中抽面板

DREAM BOX (MEDIUM INNER DRAWER WITH GLASS-BOXSIDE AND SQUARE RAIL)

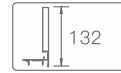

载重: 35公斤
长度: 250-600mm
抽帮高度: 132mm
面板倾斜调节: -1.5,+4
抽屉前后调节: 0-5

Load capacity: 35Kg
Length: 250-600mm
Height of drawer sides: 132mm
Front Panel tilt adjustment: -1.5,+4
Drawer depth adjustment: 0-5

滑轨安装尺寸 Installation dimensions

LW=柜内净宽 Internal cabinet width
KB=柜体宽度 Cabinet width
NL=滑轨标寸长度 Slide length
LT=柜内深度 Internal cabinet depth

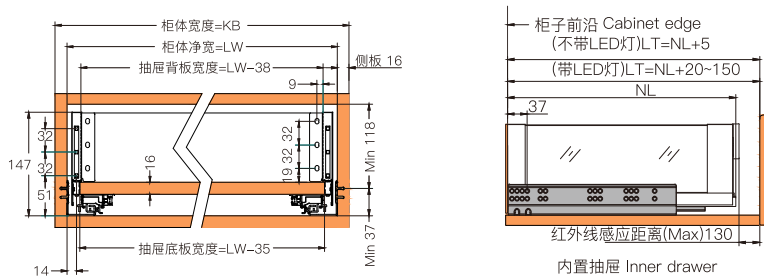

滑轨安装孔位 Hole position

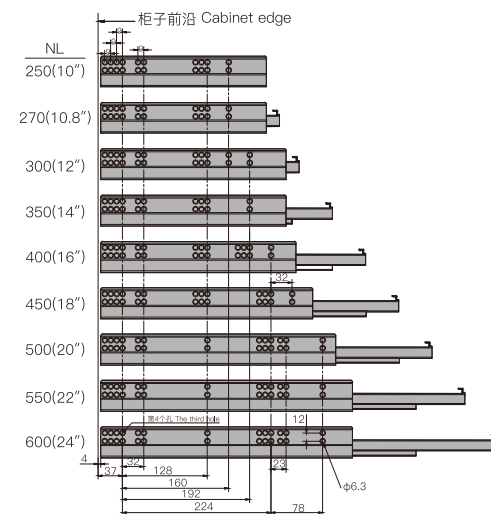

产品配件 Accessories

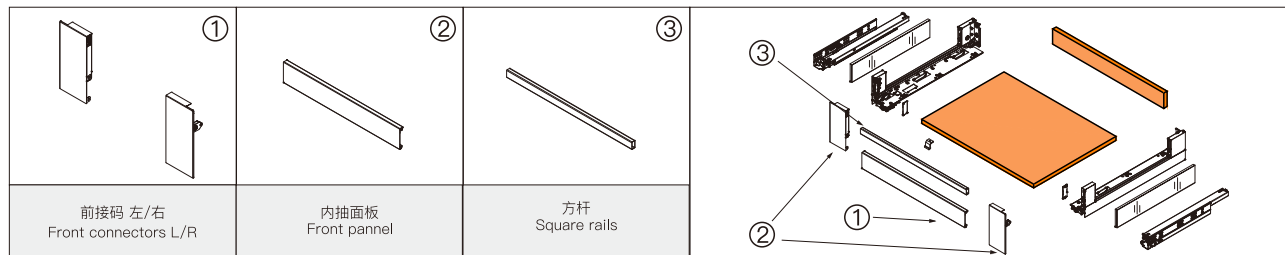

内抽面板、方杆、后背板、底板尺寸(mm) Front panel, Square rails, Rear panel, Base panel size

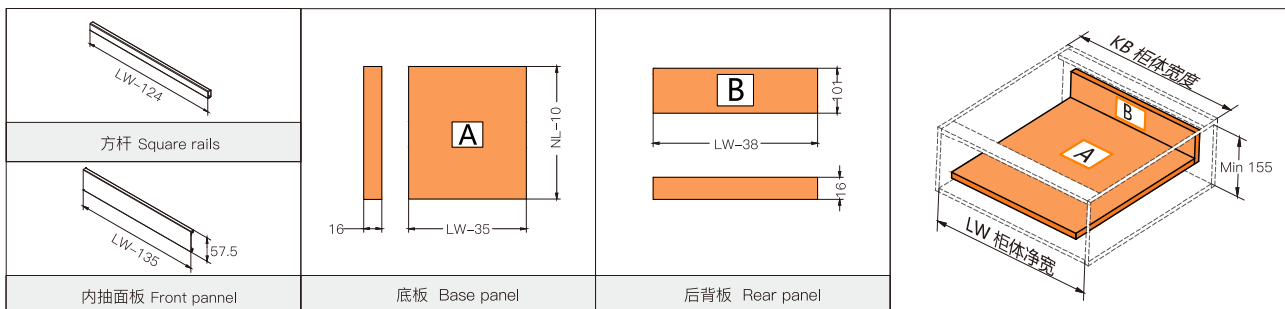

S50BM内抽 (玻璃)

梦幻玻璃抽内抽 (中抽) 适配玻璃中抽面板

DREAM BOX (MEDIUM INNER DRAWER WITH GLASS-BOXSIDE AND GLASS FRONT PANEL)

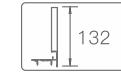

载重: 35公斤
长度: 250-600mm
抽帮高度: 132mm
面板倾斜调节: -1.5,+4
抽屉前后调节: 0-5

Load capacity: 35Kg
Length: 250-600mm
Height of drawer sides: 132mm
Front Panel tilt adjustment: -1.5,+4
Drawer depth adjustment: 0-5

滑轨安装尺寸 Installation dimensions

LW=柜内净宽 Internal cabinet width
KB=柜体宽度 Cabinet width
NL=滑轨标寸长度 Slide length
LT=柜内深度 Internal cabinet depth

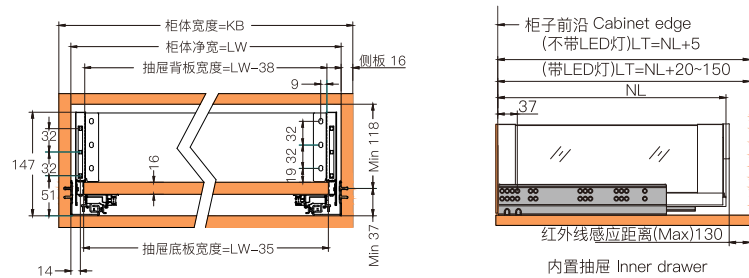

滑轨安装孔位 Hole position

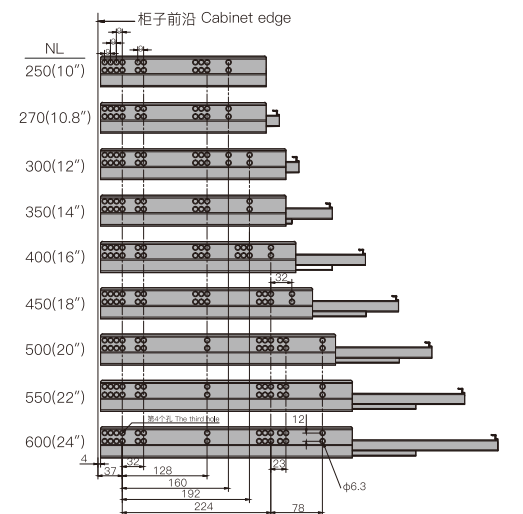

产品配件 Accessories

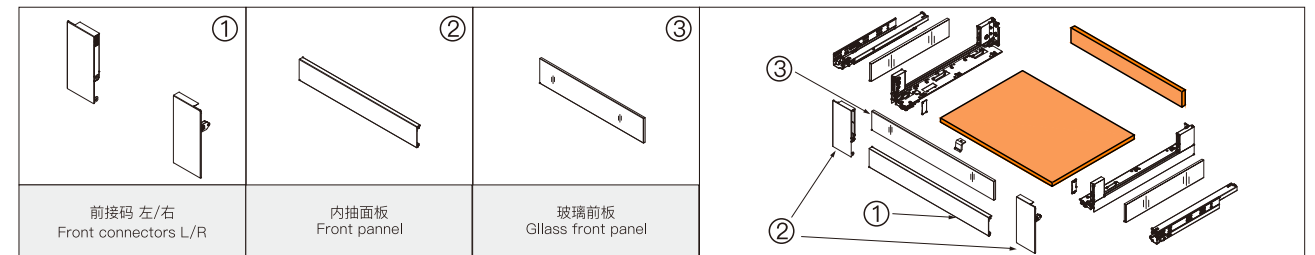

内抽面板、玻璃前板、后背板、底板尺寸(mm) Front panel, Glass, Rear panel, Base panel size

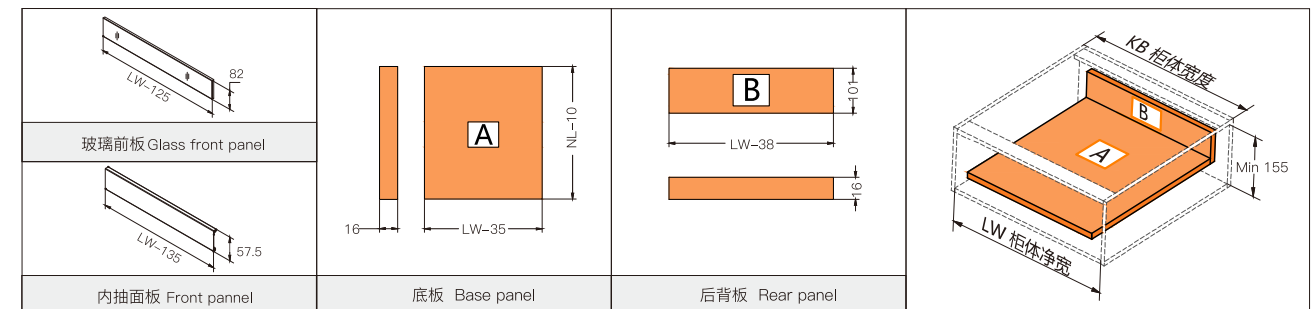

S50BH内抽 (方杆)

梦幻玻璃抽内抽 (高抽) 适配方杆高抽面板

DREAM BOX (HIGH INNER DRAWER WITH GLASS-BOXSIDE AND SQUARE RAIL)

载重: 35公斤	Load capacity: 35Kg
长度: 250-600mm	Length: 250-600mm
抽帮高度: 179mm	Height of drawer sides: 179mm
面板倾斜调节: -1.5,+4	Front Panel tilt adjustment: -1.5,+4
抽屉前后调节: 0-5	Drawer depth adjustment: 0-5



滑轨安装尺寸 Installation dimensions

LW=柜内宽度 Internal cabinet width
KB=柜体宽度 Cabinet width
NL=滑轨标称长度 Slide length
LT=柜内深度 Internal cabinet depth

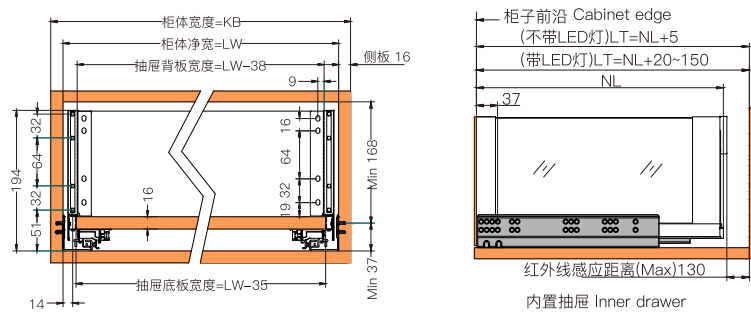

滑轨安装孔位 Hole position

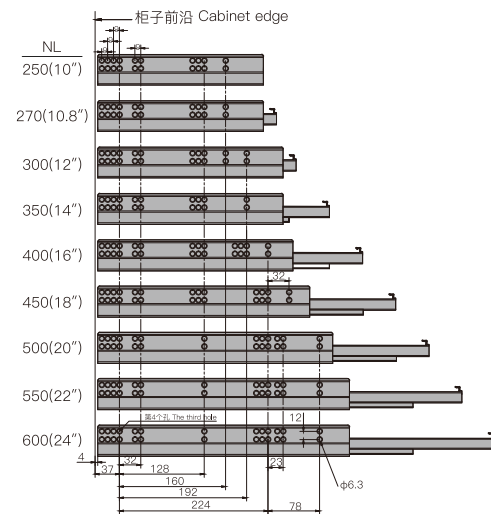

产品配件 Accessories

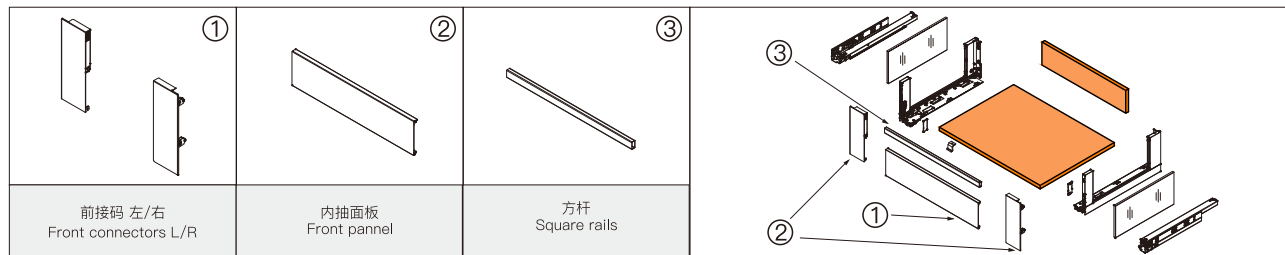

内抽面板、方杆、后背板、底板尺寸(mm) Front panel, Square rails, Rear panel, Base panel size

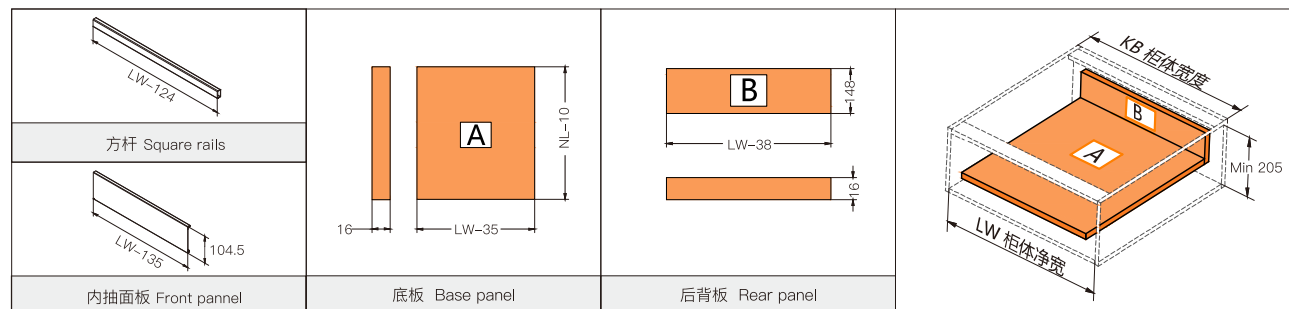

S50BH内抽 (玻璃)

梦幻玻璃抽内抽 (高抽) 适配玻璃高抽面板

DREAM BOX (HIGH INNER DRAWER WITH GLASS-BOXSIDE AND GLASS FRONT PANEL)

载重: 35公斤	Load capacity: 35Kg
长度: 250-600mm	Length: 250-600mm
抽帮高度: 179mm	Height of drawer sides: 179mm
面板倾斜调节: -1.5,+4	Front Panel tilt adjustment: -1.5,+4
抽屉前后调节: 0-5	Drawer depth adjustment: 0-5

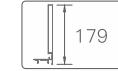

滑轨安装尺寸 Installation dimensions

LW=柜内宽度 Internal cabinet width
KB=柜体宽度 Cabinet width
NL=滑轨标称长度 Slide length
LT=柜内深度 Internal cabinet depth

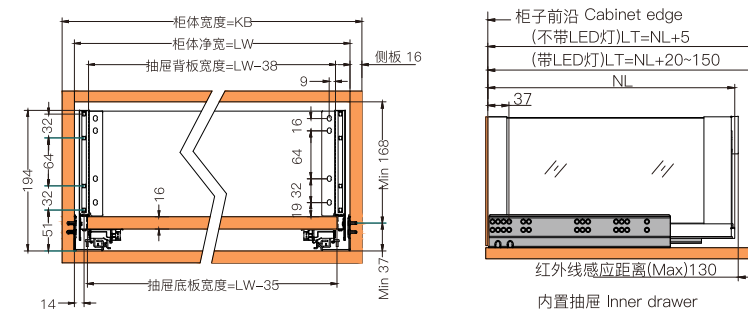

滑轨安装孔位 Hole position

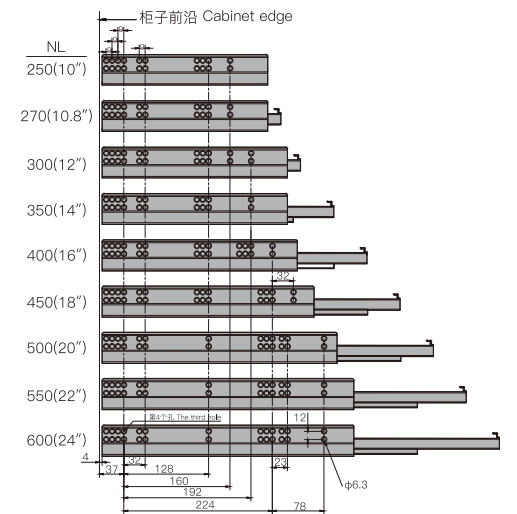

产品配件 Accessories

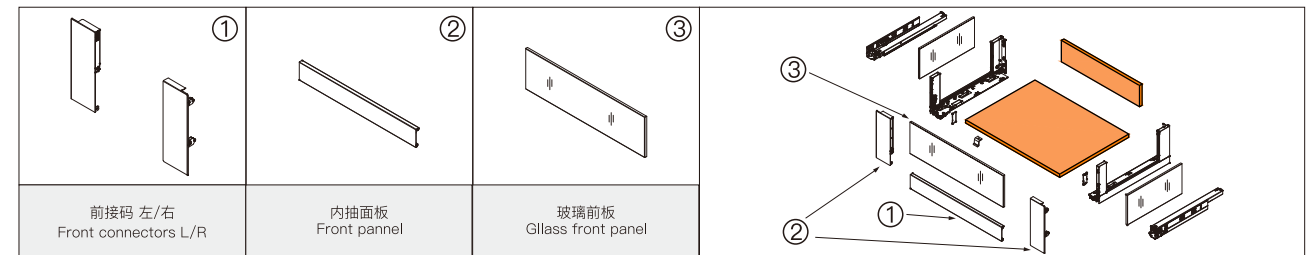

内抽面板、玻璃前板、后背板、底板尺寸(mm) Front panel, Glass, Rear panel, Base panel size

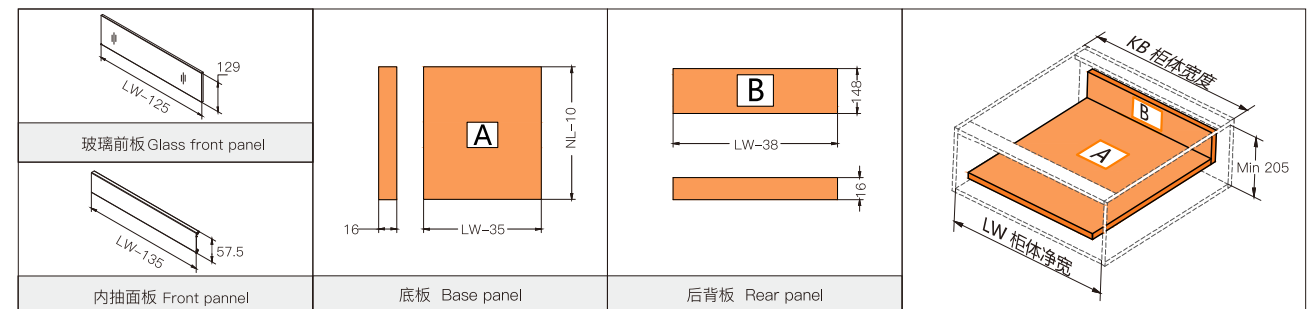



TUTTI 图特

DREAM BOX (LED GLASS-BOXSIDE)
S50梦幻玻璃抽带灯

S50CL

梦幻玻璃抽带灯 (低抽)

DREAM BOX (LOW DRAWER WITH LED GLASS-BOXSIDE)



载重: 35公斤
长度: 250-600mm
抽帮高度: 94mm
面板左右调节: ± 1.2
面板上下调节: ± 2
面板倾斜调节: $-1.5, +4$
抽屉前后调节: 0-5

Load capacity: 35Kg
Length: 250-600mm
Height of drawer sides: 94mm
Front Panel width adjustment: ± 1.2
Front Panel height adjustment: ± 2
Front Panel tilt adjustment: $-1.5, +4$
Drawer depth adjustment: 0-5

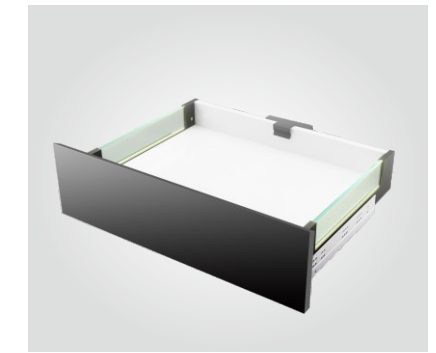

滑轨安装尺寸 Installation dimensions

LW=柜内净宽 Internal cabinet width
KB=柜体宽度 Cabinet width
NL=滑轨标寸长度 Slide length
LT=柜内深度 Internal cabinet depth

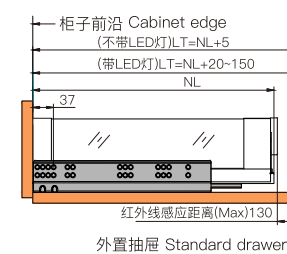
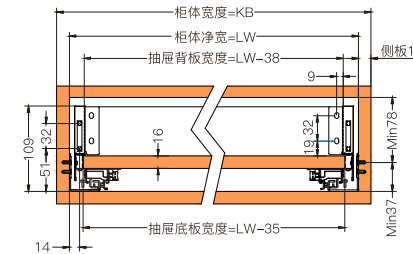

滑轨安装孔位 Hole position

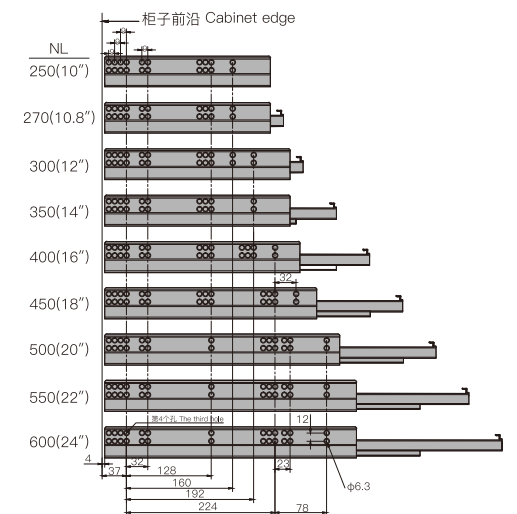

产品配件 Accessories

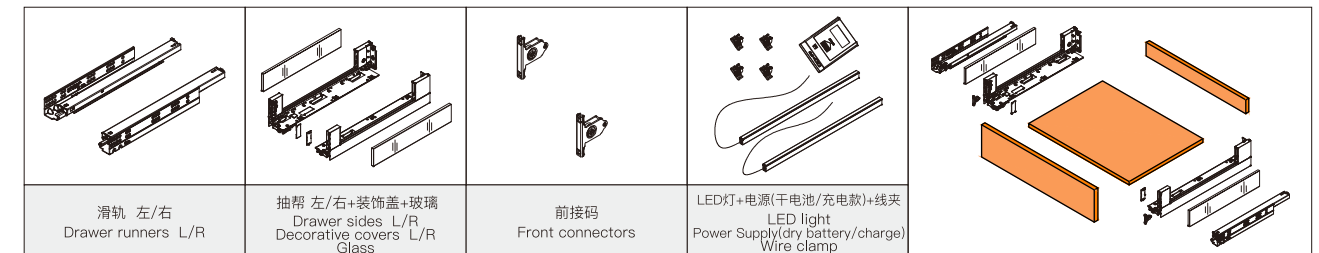

抽屉前面板、后背板、底板尺寸和钻孔(mm) Front panel, Rear panel, Base panel and drilling

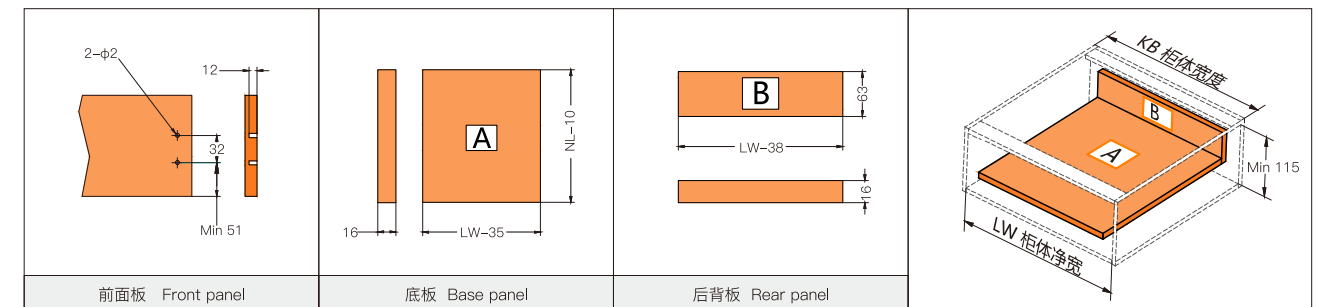

S50CM

梦幻玻璃抽带灯 (中抽)

DREAM BOX (MEDIUM DRAWER WITH LED GLASS-BOXSIDE)

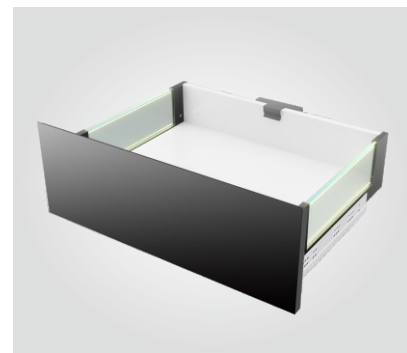
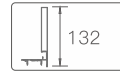

载重: 35公斤
长度: 250-600mm
抽帮高度: 132mm
面板左右调节: ± 1.2
面板上下调节: ± 2
面板倾斜调节: $-1.5, +4$
抽屉前后调节: 0-5

Load capacity: 35Kg
Length: 250-600mm
Height of drawer sides: 132mm
Front Panel width adjustment: ± 1.2
Front Panel height adjustment: ± 2
Front Panel tilt adjustment: $-1.5, +4$
Drawer depth adjustment: 0-5

滑轨安装尺寸 Installation dimensions

LW=柜内净宽 Internal cabinet width
KB=柜体宽度 Cabinet width
NL=滑轨标寸长度 Slide length
LT=柜内深度 Internal cabinet depth

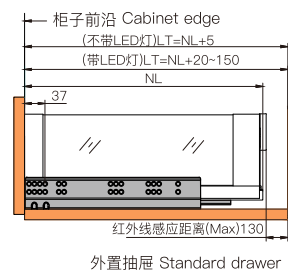
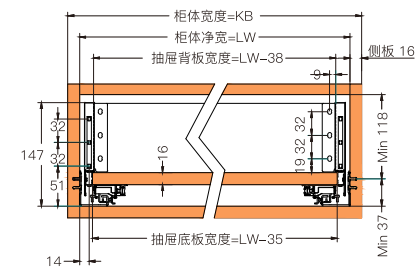

滑轨安装孔位 Hole position

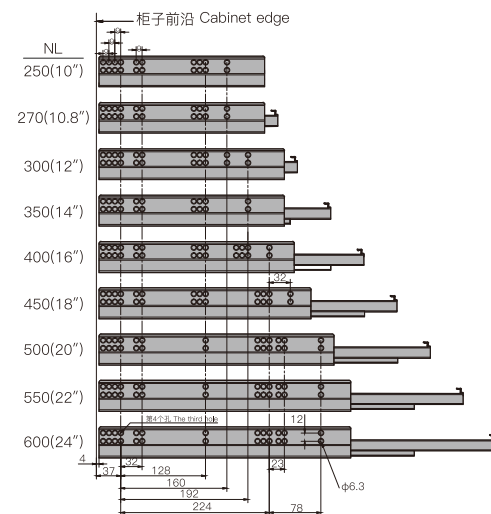

产品配件 Accessories

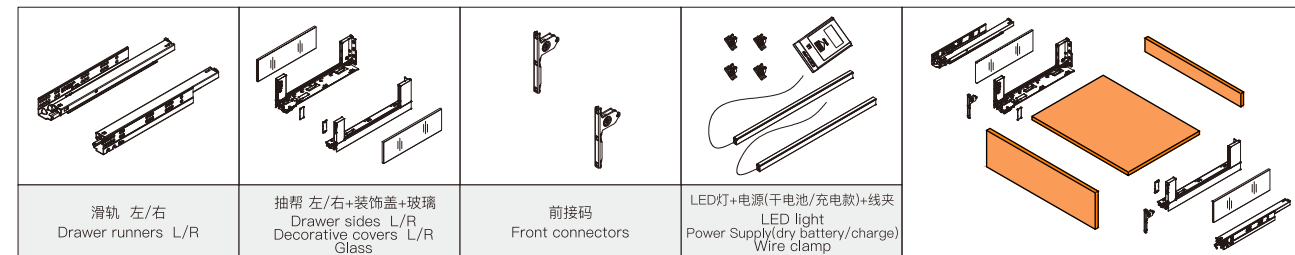

抽屉前面板、后盖板、底板尺寸和钻孔(mm) Front panel, Rear panel, Base panel and drilling

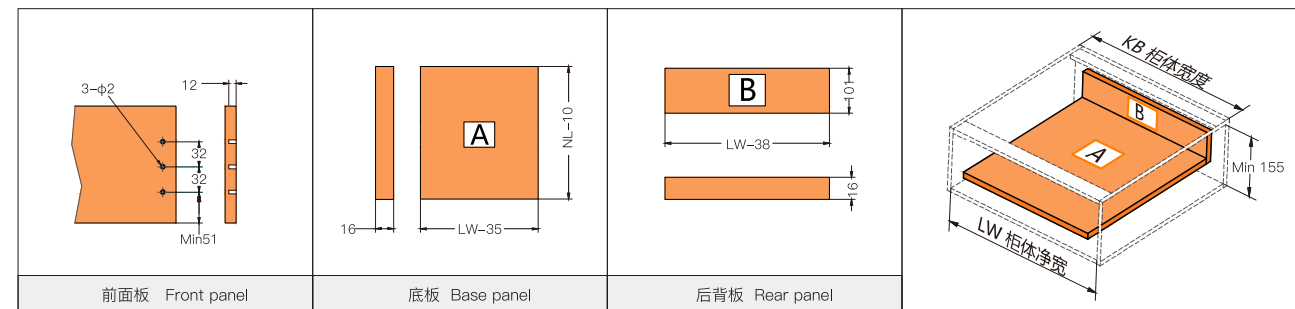

S50CH

梦幻玻璃抽带灯 (高抽)

DREAM BOX (HIGH DRAWER WITH LED GLASS-BOXSIDE)

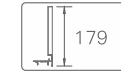

载重: 35公斤
长度: 250-600mm
抽帮高度: 179mm
面板左右调节: ± 1.2
面板上下调节: ± 2
面板倾斜调节: $-1.5, +4$
抽屉前后调节: 0-5

Load capacity: 35Kg
Length: 250-600mm
Height of drawer sides: 179mm
Front Panel width adjustment: ± 1.2
Front Panel height adjustment: ± 2
Front Panel tilt adjustment: $-1.5, +4$
Drawer depth adjustment: 0-5

滑轨安装尺寸 Installation dimensions

LW=柜内净宽 Internal cabinet width
KB=柜体宽度 Cabinet width
NL=滑轨标寸长度 Slide length
LT=柜内深度 Internal cabinet depth

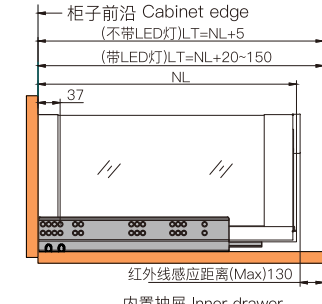
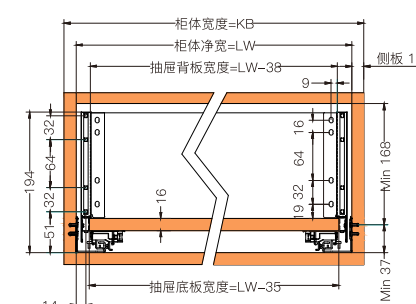

滑轨安装孔位 Hole position

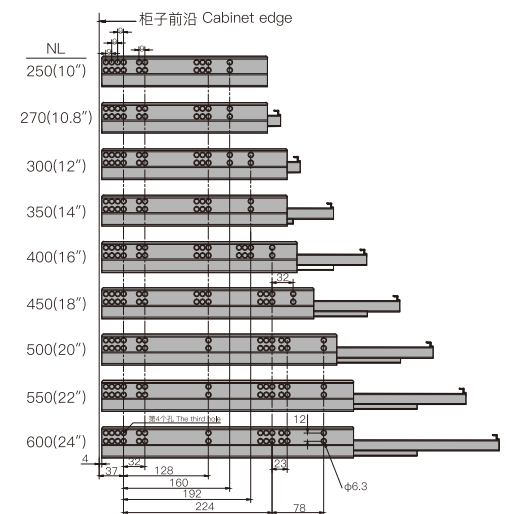

产品配件 Accessories

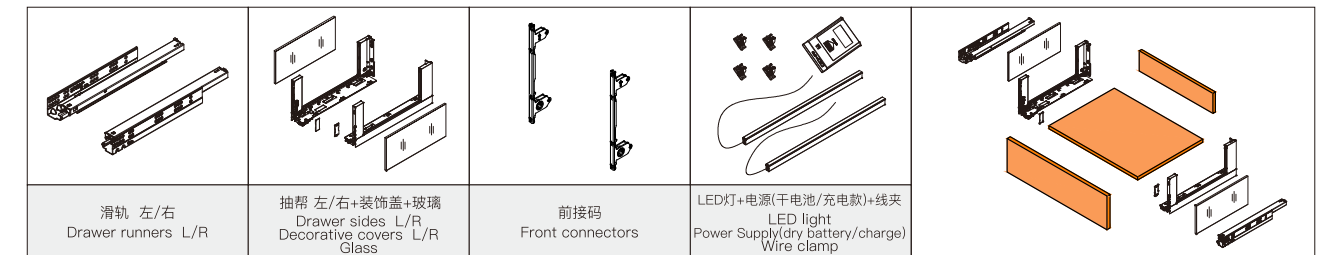

抽屉前面板、后盖板、底板尺寸和钻孔(mm) Front panel, Rear panel, Base panel and drilling

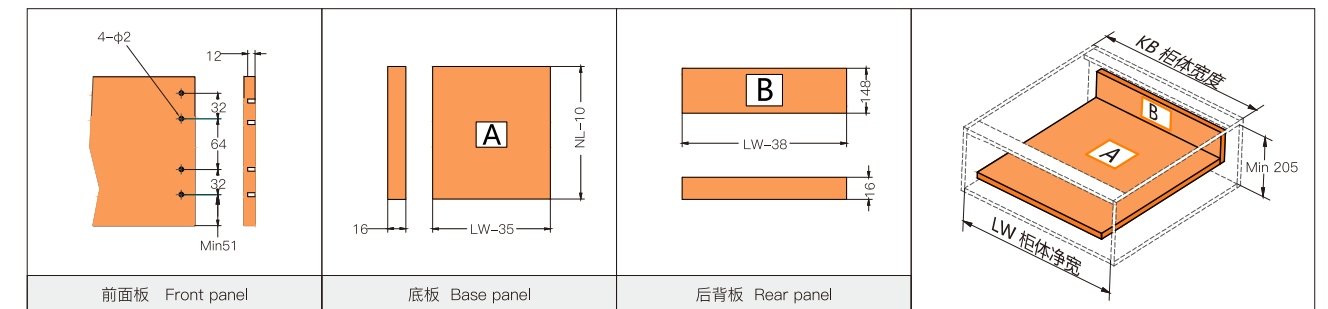

S50CL内抽

梦幻玻璃抽带灯内抽 (低抽) DREAM BOX (LOW INNER DRAWER WITH LED GLASS-BOXSIDE)

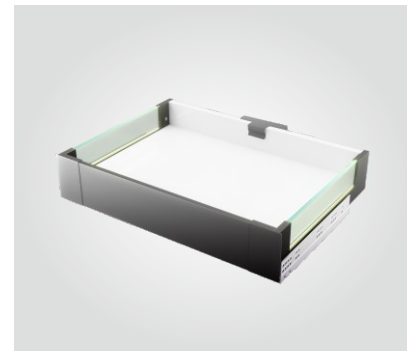
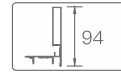

载重: 35公斤
长度: 250-600mm
抽帮高度: 94mm
面板倾斜调节: -1.5,+4
抽屉前后调节: 0-5

Load capacity: 35Kg
Length: 250-600mm
Height of drawer sides: 94mm
Front Panel tilt adjustment: -1.5,+4
Drawer depth adjustment: 0-5

滑轨安装尺寸 Installation dimensions

LW=柜内净宽 Internal cabinet width
KB=柜体宽度 Cabinet width
NL=滑轨标寸长度 Slide length
LT=柜内深度 Internal cabinet depth

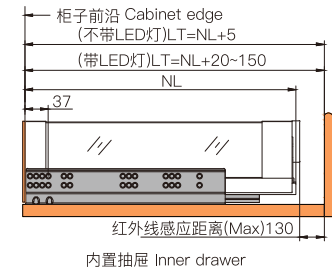
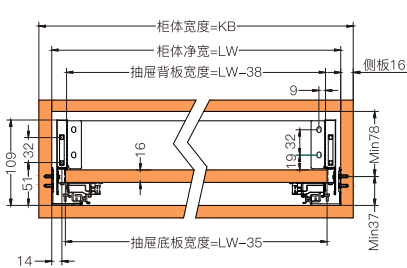

滑轨安装孔位 Hole position

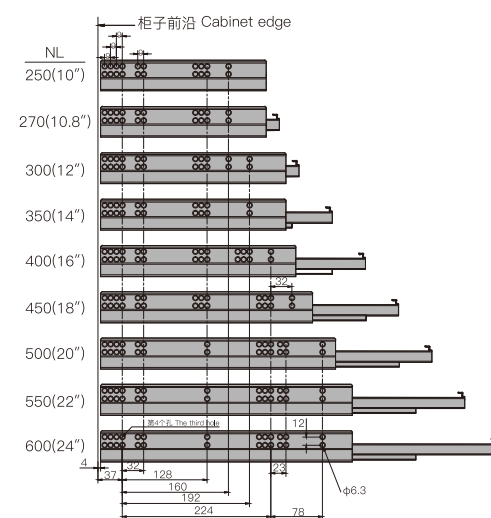

产品配件 Accessories

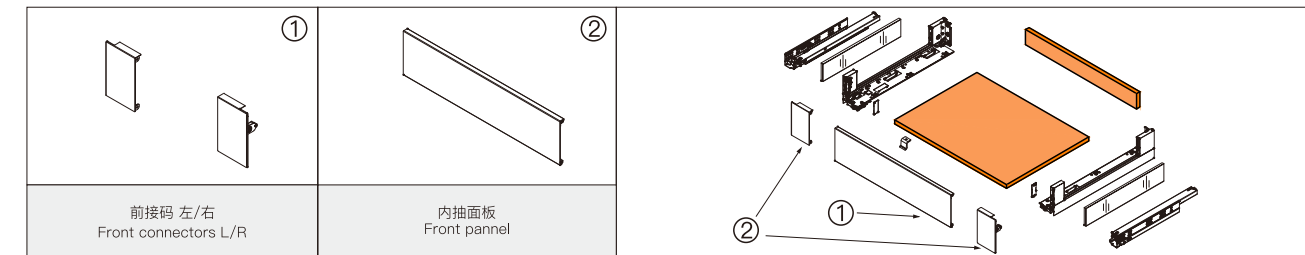

内抽面板、后背板、底板尺寸(mm) Front panel, Rear panel, Base panel size

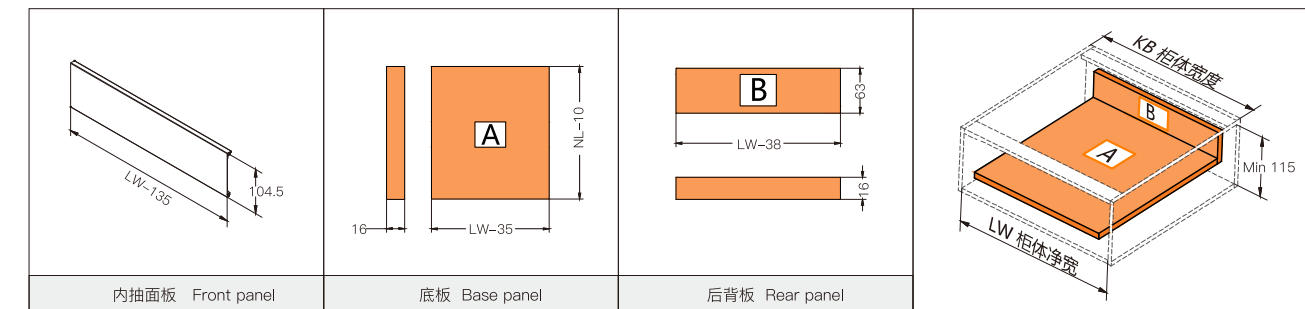

S50CL内抽 (玻璃)

梦幻玻璃抽带灯内抽 (低抽) 适配玻璃低抽面板 DREAM BOX (LOW INNER DRAWER WITH LED GLASS-BOXSIDE AND GLASS FRONT PANEL)

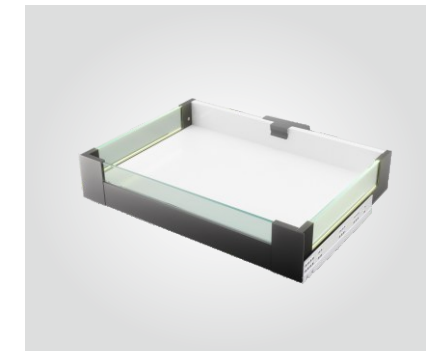
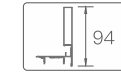

载重: 35公斤
长度: 250-600mm
抽帮高度: 94mm
面板倾斜调节: -1.5,+4
抽屉前后调节: 0-5

Load capacity: 35Kg
Length: 250-600mm
Height of drawer sides: 94mm
Front Panel tilt adjustment: -1.5,+4
Drawer depth adjustment: 0-5

滑轨安装尺寸 Installation dimensions

LW=柜内净宽 Internal cabinet width
KB=柜体宽度 Cabinet width
NL=滑轨标寸长度 Slide length
LT=柜内深度 Internal cabinet depth

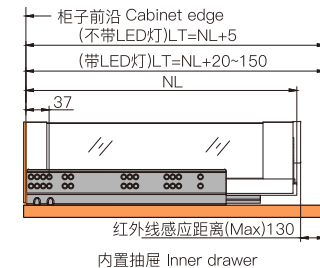
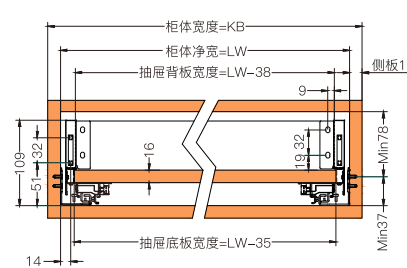

滑轨安装孔位 Hole position

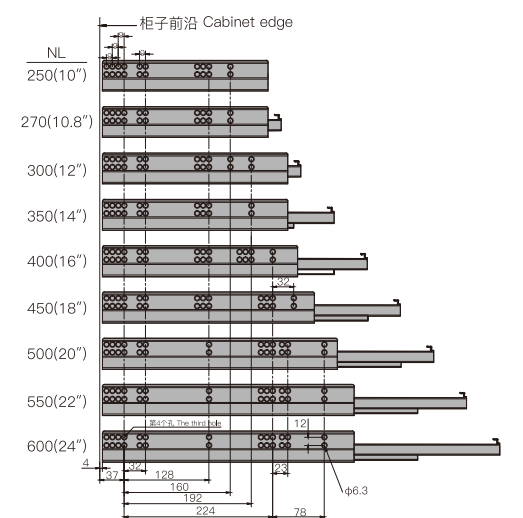

产品配件 Accessories

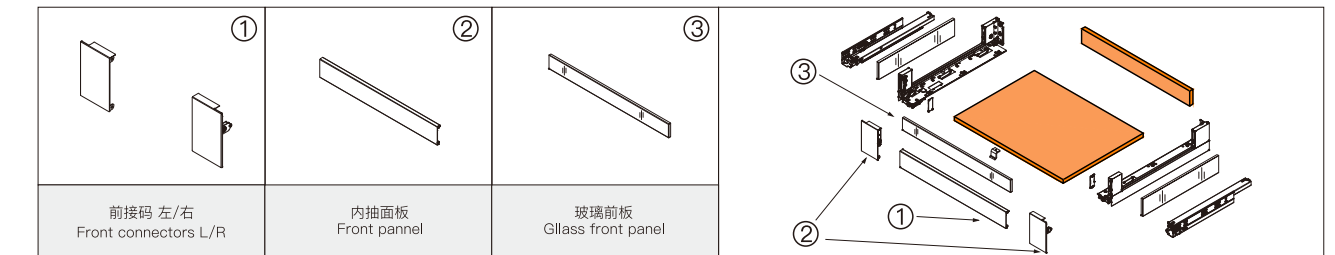

内抽面板、玻璃前板、后背板、底板尺寸(mm) Front panel, Glass, Rear panel, Base panel size

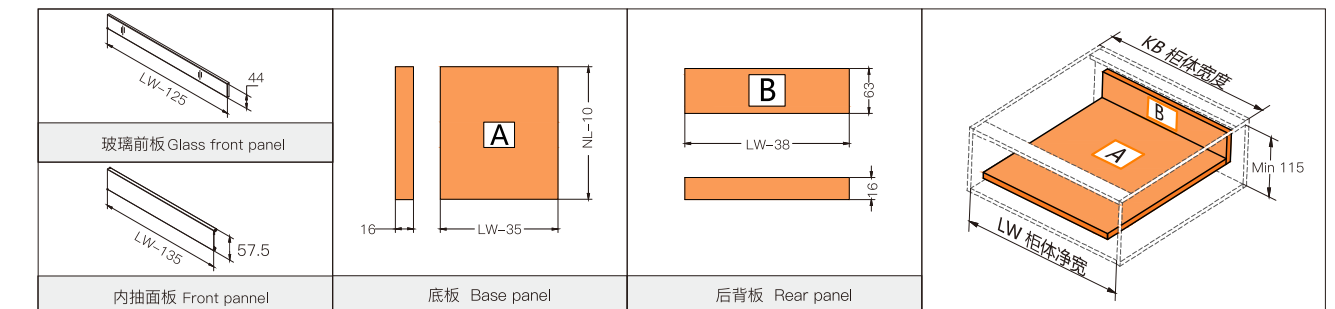

S50CM内抽 (方杆)

梦幻玻璃抽带灯内抽 (中抽) 适配方杆中抽面板

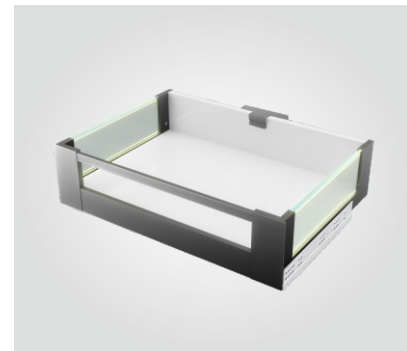
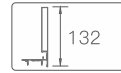

DREAM BOX (MEDIUM INNER DRAWER)
WITH LED GLASS-BOXSIDE AND SQUARE RAIL

载重: 35公斤 Load capacity: 35Kg
 长度: 250-600mm Length: 250-600mm
 抽帮高度: 132mm Height of drawer sides: 132mm
 面板倾斜调节: -1.5,+4 Front Panel tilt adjustment: -1.5,+4
 抽屉前后调节: 0-5 Drawer depth adjustment: 0-5

滑轨安装尺寸 Installation dimensions

LW=柜内净宽 Internal cabinet width
 KB=柜体宽度 Cabinet width
 NL=滑轨标寸长度 Slide length
 LT=柜内深度 Internal cabinet depth

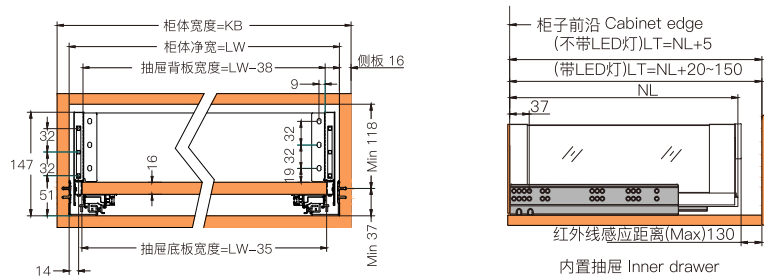

滑轨安装孔位 Hole position

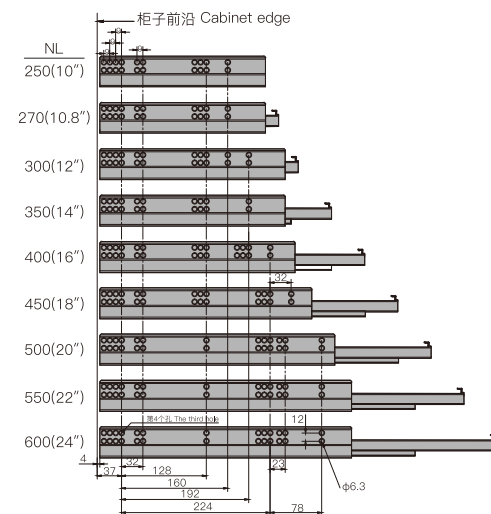

产品配件 Accessories

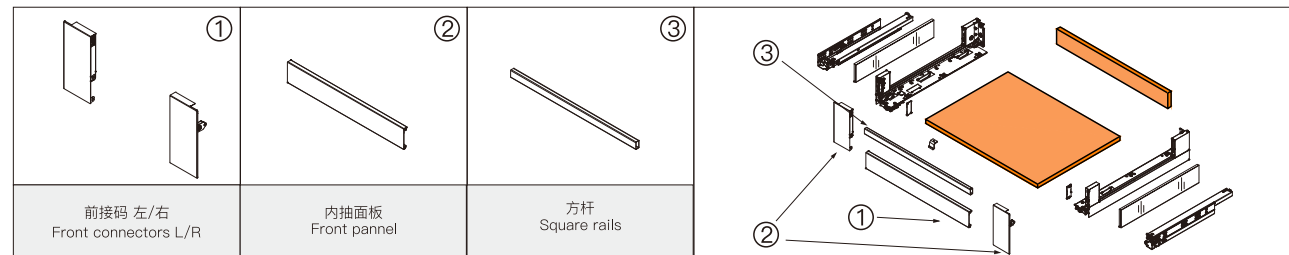

内抽面板、方杆、后背板、底板尺寸(mm) Front panel, Square rails, Rear panel, Base panel size

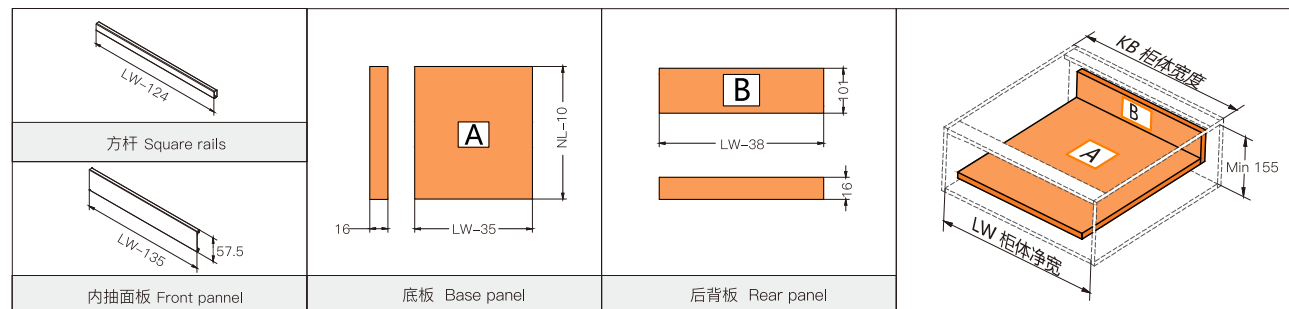

S50CM内抽 (玻璃)

梦幻玻璃抽带灯内抽 (中抽) 适配玻璃中抽面板

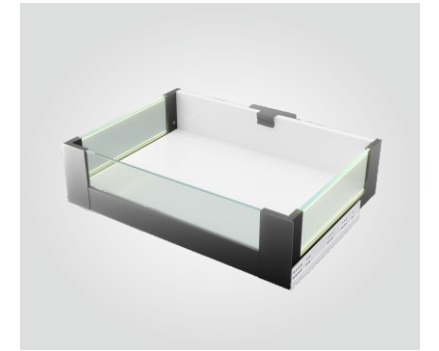
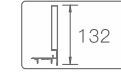

DREAM BOX (MEDIUM INNER DRAWER)
WITH LED GLASS-BOXSIDE AND GLASS FRONT PANEL

载重: 35公斤 Load capacity: 35Kg
 长度: 250-600mm Length: 250-600mm
 抽帮高度: 132mm Height of drawer sides: 132mm
 面板倾斜调节: -1.5,+4 Front Panel tilt adjustment: -1.5,+4
 抽屉前后调节: 0-5 Drawer depth adjustment: 0-5

滑轨安装尺寸 Installation dimensions

LW=柜内净宽 Internal cabinet width
 KB=柜体宽度 Cabinet width
 NL=滑轨标寸长度 Slide length
 LT=柜内深度 Internal cabinet depth

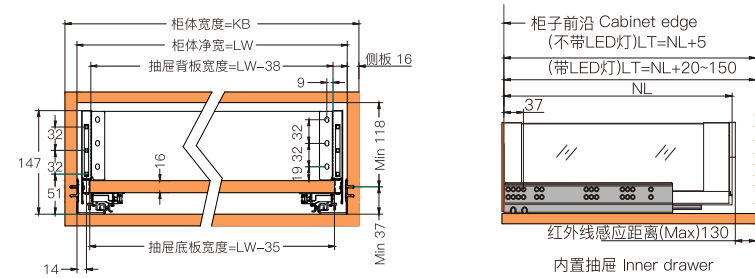

滑轨安装孔位 Hole position

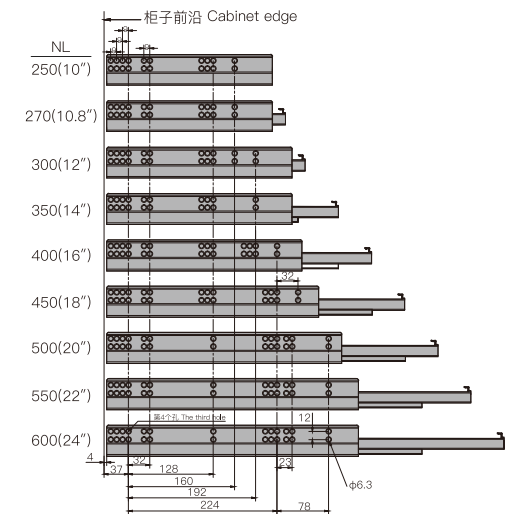

产品配件 Accessories

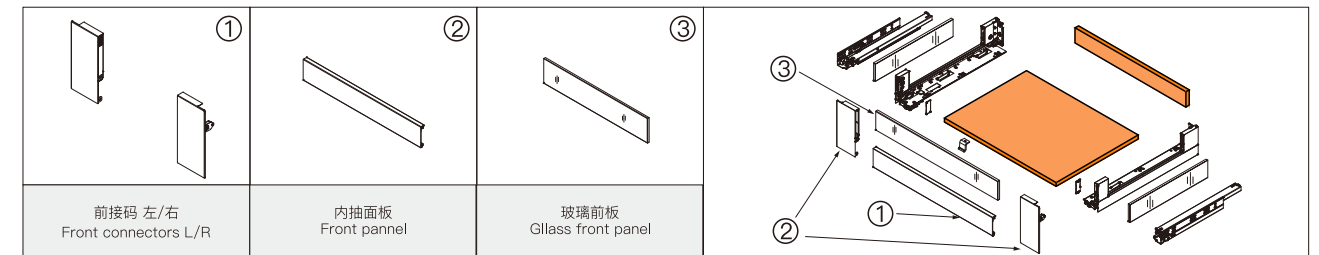

内抽面板、玻璃前板、后背板、底板尺寸(mm) Front panel, Glass, Rear panel, Base panel size

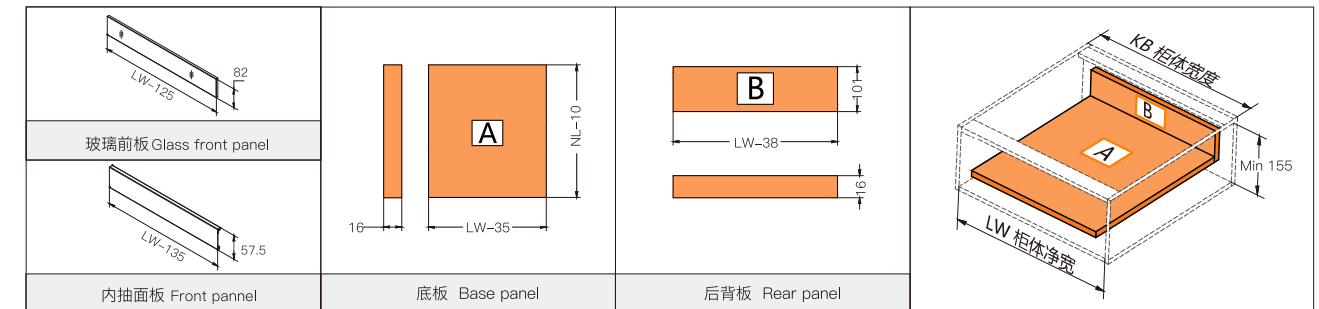

S50CH内抽 (方杆)

梦幻玻璃抽带灯内抽 (高抽) 适配方杆高抽面板

DREAM BOX (HIGH INNER DRAWER WITH LED GLASS-BOXSIDE AND SQUARE RAIL)

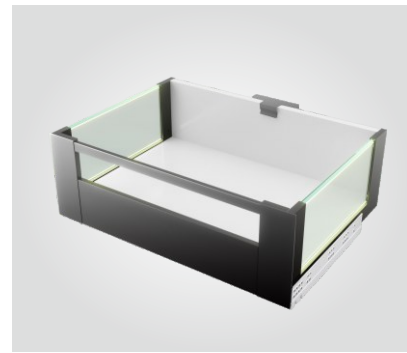

载重: 35公斤
长度: 250-600mm
抽帮高度: 179mm
面板倾斜调节: -1.5,+4
抽屉前后调节: 0-5

Load capacity: 35Kg
Length: 250-600mm
Height of drawer sides: 179mm
Front Panel tilt adjustment: -1.5,+4
Drawer depth adjustment: 0-5

滑轨安装尺寸 Installation dimensions

LW=柜内宽度 Internal cabinet width
KB=柜体宽度 Cabinet width
NL=滑轨标称长度 Slide length
LT=柜内深度 Internal cabinet depth

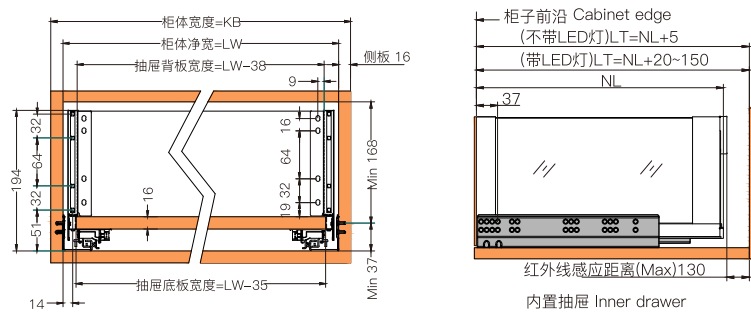

滑轨安装孔位 Hole position

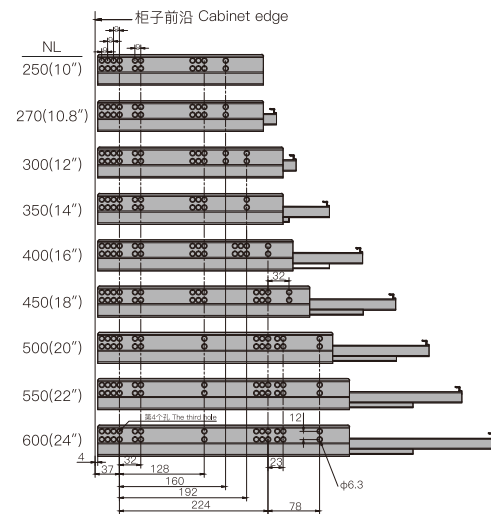

产品配件 Accessories

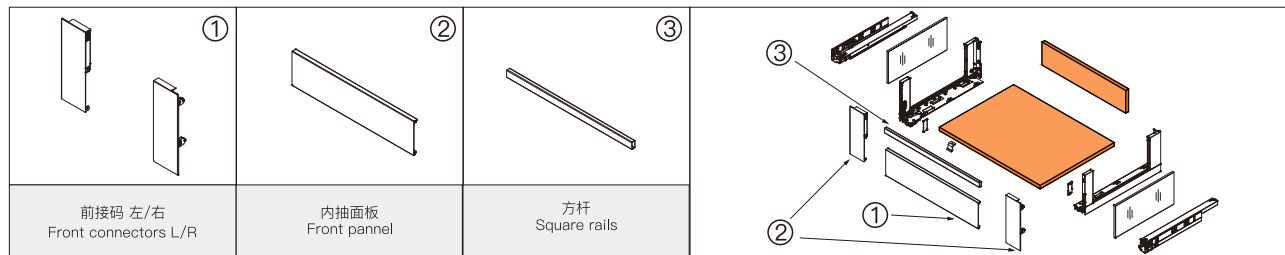

内抽面板、方杆、后背板、底板尺寸(mm) Front panel, Square rails, Rear panel, Base panel size

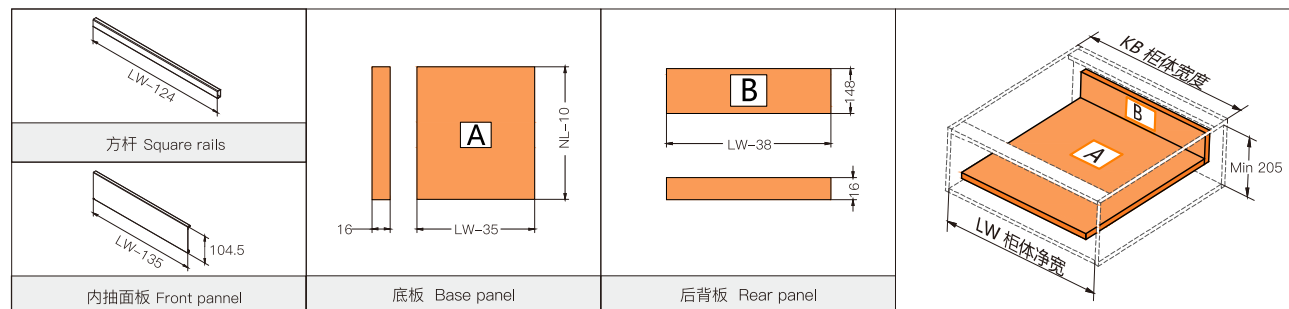

S50CH内抽 (玻璃)

梦幻玻璃抽带灯内抽 (高抽) 适配玻璃高抽面板

DREAM BOX (HIGH INNER DRAWER WITH LED GLASS-BOXSIDE AND GLASS FRONT PANEL)

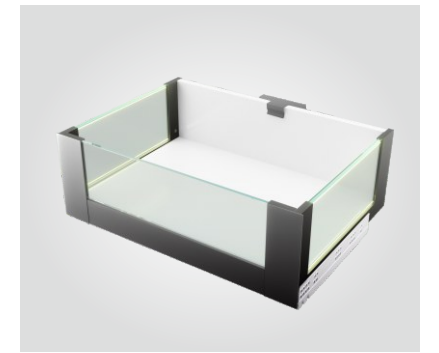
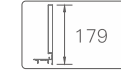

载重: 35公斤
长度: 250-600mm
抽帮高度: 179mm
面板倾斜调节: -1.5,+4
抽屉前后调节: 0-5

Load capacity: 35Kg
Length: 250-600mm
Height of drawer sides: 179mm
Front Panel tilt adjustment: -1.5,+4
Drawer depth adjustment: 0-5

滑轨安装尺寸 Installation dimensions

LW=柜内宽度 Internal cabinet width
KB=柜体宽度 Cabinet width
NL=滑轨标称长度 Slide length
LT=柜内深度 Internal cabinet depth

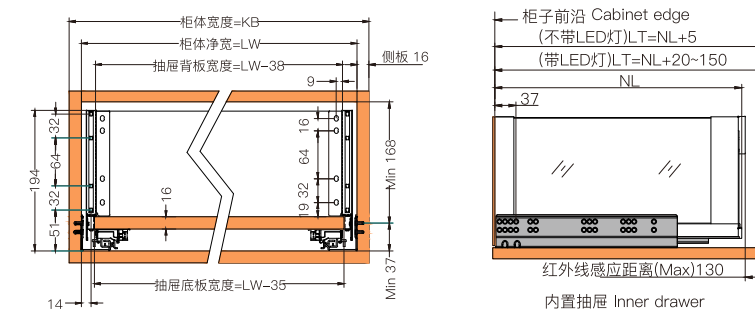

滑轨安装孔位 Hole position

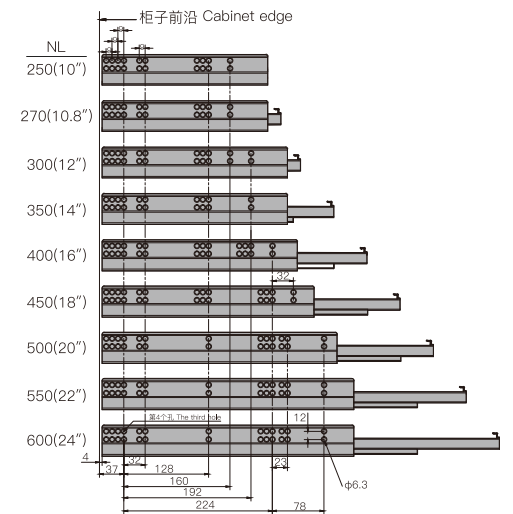

产品配件 Accessories

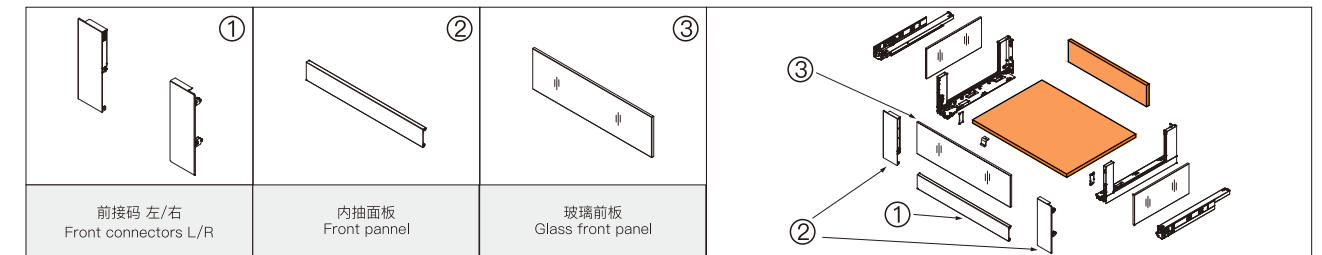

内抽面板、玻璃前板、后背板、底板尺寸(mm) Front panel, Glass, Rear panel, Base panel size

